

## Review Article

# The Virtuous CO<sub>2</sub> Circle or the Three Cs: Capture, Cache, and Convert

**Sergio Bocchini,<sup>1</sup> Carlos Castro,<sup>2</sup> Matteo Cocuzza,<sup>3,4</sup> Sergio Ferrero,<sup>3</sup> Giulio Latini,<sup>1,3</sup> Alberto Martis,<sup>1,3</sup> Fabrizio Pirri,<sup>1,3</sup> Luciano Scaltrito,<sup>3</sup> Vera Rocca,<sup>5</sup> Francesca Verga,<sup>5</sup> and Dario Viberti<sup>5</sup>**

<sup>1</sup>Center for Sustainable Future Technologies, Istituto Italiano di Tecnologia, Corso Trento 21, 10129 Torino, Italy

<sup>2</sup>DREAM, Corso Trento 5, 10129 Torino, Italy

<sup>3</sup>Dipartimento di Scienza Applicata e Tecnologia (DISAT), Politecnico di Torino, Corso Duca degli Abruzzi 24, 10129 Torino, Italy

<sup>4</sup>IMEM-CNR, Parco Area delle Scienze 37, 43124 Parma, Italy

<sup>5</sup>Dipartimento di Ingegneria dell'Ambiente, del Territorio e delle Infrastrutture (DIATI), Politecnico di Torino, Corso Duca degli Abruzzi 24, 10129 Torino, Italy

Correspondence should be addressed to Francesca Verga; francesca.verga@polito.it

Received 24 February 2017; Revised 20 April 2017; Accepted 10 May 2017; Published 21 June 2017

Academic Editor: Camilo A. Franco

Copyright © 2017 Sergio Bocchini et al. This is an open access article distributed under the Creative Commons Attribution License, which permits unrestricted use, distribution, and reproduction in any medium, provided the original work is properly cited.

It is not the first time in human history, nor will it be the last for that matter, that a collective problem calls for a collective response. Climate change fueled by greenhouse emissions affects humankind alike. Despite the disagreement among policymakers and scientists on the severity of the issue, the truth is that the problem remains. A broad look at different technologies being used today in different fields has led to the idea of bringing them together in an attempt to offer a viable solution to reducing anthropogenic CO<sub>2</sub>. The following paper describes how the nanotechnologies, available or soon to be available, would make CO<sub>2</sub> capture, cache, and conversion (coined the three Cs) a valid way for achieving a more sustainable energy society. Authors also set out to highlight with this work how knowledge transfer is instrumental in the development of technology and how methodical assessment of crossovers can expedite research when time plays against us.

## 1. Introduction

Surely, many have heard of the three Rs (reduce, reuse, and recycle), if not in some environmental guidelines campaign then at least in the way of a catchy song. It may also be known to some that the most effective way to reduce waste is to not create it in the first place, but we must agree that this is nearly impossible in our developed socioeconomical order. Consequently, over the past decades, we have chosen to create a ridiculous amount of waste, mostly from making *new* products. Each and every *new product* has an environmental footprint which could be defined as the amount of harmful gases *produced* in the *production* process. These “harmful gases” are also referred to as greenhouse gases, carbon dioxide (CO<sub>2</sub>) being one of them. Somewhat contradictorily, CO<sub>2</sub> is vital to life on Earth; it naturally occurs in groundwater,

rivers, and lakes, in ice caps and glaciers, and in seawater as well. Thus, the true problem lies in the amount of anthropogenic CO<sub>2</sub>. And this is where the three Rs come in; would it be fair to say we have reached a point in which CO<sub>2</sub> can be reduced, reused, and recycled? The following paper addresses this issue by describing how we could potentially capture and store CO<sub>2</sub> with the aim of recycling it (by turning it into methane, CH<sub>4</sub>, in a not so distant future) by using nanomaterials and nanotechnologies. Authors stand corrected: the following paper addresses the above while connecting and sharing the knowledge among the different disciplines that would be involved in the execution of this potentially environmentally friendly task.

Three technologies are necessary to *reduce*, *reuse*, and *recycle* CO<sub>2</sub>, namely, CO<sub>2</sub> capture, CO<sub>2</sub> cache (store), and CO<sub>2</sub> convert (or the three Cs); only time will tell whether the

three Cs will become as popular as the three Rs or even song-worthy. It should be noted that even if all the technologies to capture, store, and convert  $\text{CO}_2$  have been given a lot of consideration lately, they are all at different investigational stages; thus, deploying all of them simultaneously still requires research and development. Nonetheless, the purpose of the present work is to show the readership the value and potential benefits of integrating these so far seemingly *isolated* technologies. It is no secret that, in spite of living in a highly connected society, scientific interdisciplinary communication is yet far from being adequate. Much to our detriment, but even more so to that of the future generations, the nearly complete dissociation between the different sectors of society has led to the current state of paralysis we find ourselves in with respect to environmental policy consensus. People working in the sciences cannot afford to keep on making the same mistake. Because time is of the essence, technologies that have proven to be safe and efficient in some fields should be considered as valid alternatives for deployment in other fields. For instance, decades of underground gas storage experience in the oil and gas industry can be transferred to fill the knowledge gaps of  $\text{CO}_2$  storage within a virtuous  $\text{CO}_2$  circle. In fact, great emphasis has been currently placed on  $\text{CO}_2$  capture technologies, which stem from the somewhat recent branch of science broadly known as nanotechnology. Available capture technologies are not yet ready for use at the industrial scale, mainly for lack of efficiency, but the latest research shows promising results and  $\text{CO}_2$  capture might soon be scaled up. On the other hand, however, conversion of  $\text{CO}_2$  into  $\text{CH}_4$  is still more a perspective target than an actual possibility in the short term. In short,  $\text{CO}_2$  could be captured and then stored underground, consequently reducing emissions into the atmosphere; subsequently, it could be exploited as a valuable resource when the necessary technology overcomes its bleeding edge.

Finally, authors are perfectly aware that current practices will not simply change based on just one paper, but our work is meant just as a starting point for a combined effort directed at an energy sustainable society. We also understand that many will argue against the cost-effectiveness of our proposed “capture, cache, and convert  $\text{CO}_2$  process” considering the large amount of energy the process will require and hence impact on the whole system costs. Yet, we expect not only that the technology will become more energy efficient once the experimental phase leads the way to more commercial-scale projects, but also that  $\text{CO}_2$  storage itself will become an incentive because of its potential conversion into  $\text{CH}_4$ . To date, more than 230  $\text{CO}_2$  capture and/or storage operations (including in-development and completed ones) have been carried out worldwide (according to a report published by the US Clean Coal Research Program, 2013).

In our present reality, it is often very difficult to tell “energy from waste” from “waste from energy,” thus the importance of knowledge sharing among different scientific disciplines in order to avoid ending up in yet another vicious (energy) cycle. Lastly, let us not forget that this technology is originally meant to serve the energy transition to a lower carbon society by reducing the carbon intensity of the energy

system, notwithstanding it could also prove useful in a longer term as well.

## 2. Capture: Current and Upcoming Technologies

**2.1. Direct Air Capture of  $\text{CO}_2$ .** Since the beginning of industrialization, the atmospheric concentration of  $\text{CO}_2$  has increased by 30% to about 400 ppm today [1, 2]. The Direct Air Capture (DAC) concept defined as the direct extraction of  $\text{CO}_2$  from ambient air was introduced in 1999 [3] and a decade was spent on the viability of this technique as a potential climate change mitigation technology; in the following half decade, there was even increased interest with a large number of publications, but the current technologies do not provide energy/economical efficient separation of  $\text{CO}_2$  since concentration in the atmosphere is too low. Thus, DAC techniques, which were effectively reviewed in a recent article by Sanz-Pérez et al. [4], are not of particular interest in this paper.

**2.2. Flue Gases and Other  $\text{CO}_2$ -Rich Gases.** Nowadays, the efforts are mainly concentrated on  $\text{CO}_2$ -rich combustion gases such as postcombustion, oxyfuel, and precombustion gases. Postcombustion capture entails separating  $\text{CO}_2$  from the flue gas emitted after combustion in the air.  $\text{CO}_2$  separation is carried out from a gaseous stream mainly composed of  $\text{N}_2$  at atmospheric pressure and with low  $\text{CO}_2$  concentration (*ca.* 5–25%). Other gases such as  $\text{SO}_2$ ,  $\text{NO}_2$ , and  $\text{O}_2$  may also be present in small amounts. It is also the most widely applicable option in industrial sectors (e.g., the cement industry is responsible for over 5% of the total carbon dioxide emissions). In this case, the  $\text{CO}_2$  derives from fuel combustion and  $\text{CaCO}_3$  calcination and reaches 25% on dry bases of exhaust gas  $\text{CO}_2$  facilitating the extraction. Postcombustion  $\text{CO}_2$  capture has the advantage of being applied to existing plants retrofitting the technology.

In oxyfuel combustion, fuel is burnt in the presence of oxygen instead of air. By eliminating nitrogen and recirculating flue gas, the concentration of  $\text{CO}_2$  is increased. The main advantage is the achievement of a purge stream rich in  $\text{CO}_2$  and water with very low nitrogen content.  $\text{CO}_2$  can be easily recovered after the condensation of water vapor.

$\text{CO}_2$  capture from precombustion gases is applied to syngas produced from carbon sources (e.g., natural gas, coal, biomass, or virtually any hydrocarbon feedstock by reaction with water or oxygen). In this case,  $\text{CO}_2$  capture also presents the advantage of increasing energy density [5].

**2.3. Current Technologies for  $\text{CO}_2$  Capture.** Absorption with amines, solid adsorption, cryogenic separation, and membranes are considered conventional  $\text{CO}_2$  separation processes [6, 7] (Figure 1).

The most effective, economical, and traditional ammine used for  $\text{CO}_2$  absorption is monoethanolamine (MEA), which has been used for over 70 years in the chemical industry [8]. The process consists of a column in which MEA selectively absorbs  $\text{CO}_2$  from the gas mixture; thus,

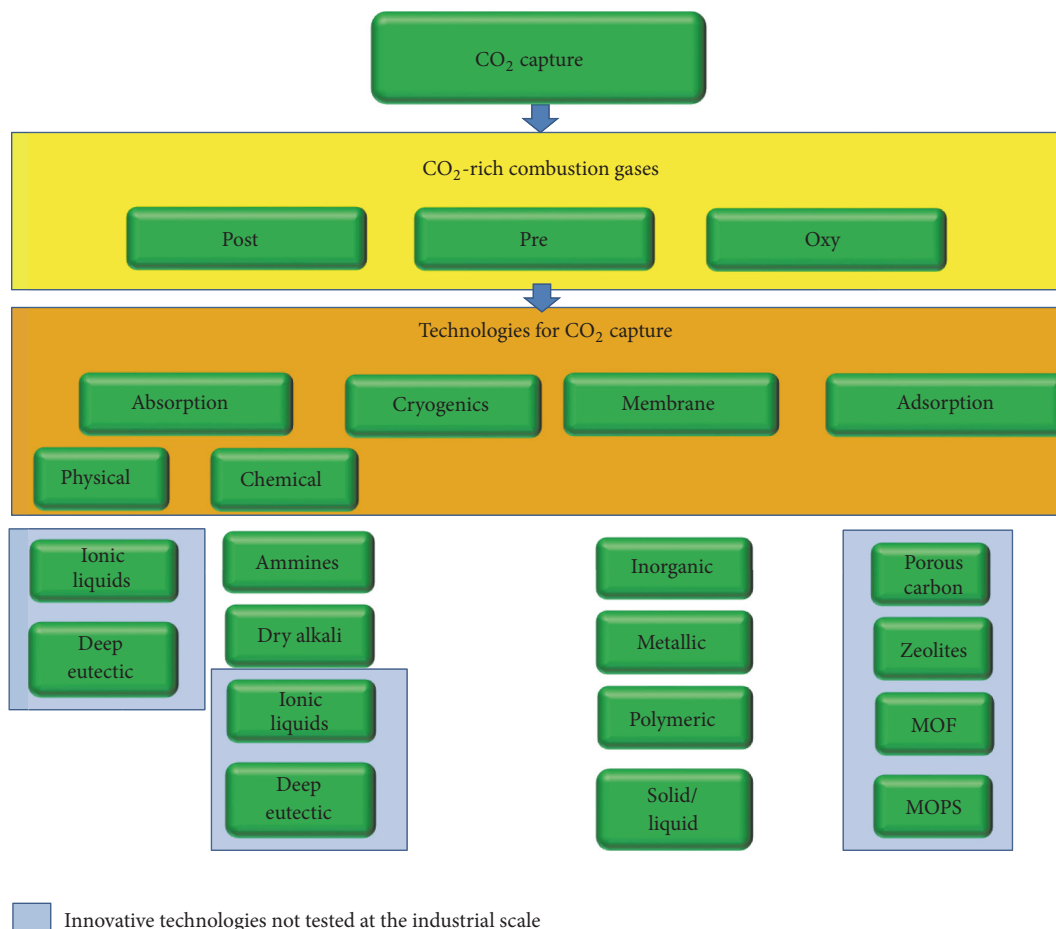

FIGURE 1: Different technologies used for CO<sub>2</sub> capture listed in this article divided by type.

the thermodynamic conditions are manipulated to allow the release of CO<sub>2</sub> into another column. Adsorption is achieved at high pressure and low temperature while desorption and regeneration are achieved at low pressure and high temperature (Figure 2). While pressure is not so important, temperature manipulation makes up 70–80% of the operating costs. To improve the process, new solvents, which can benefit from nanotechnology areas, or refined conditions are the main research options.

To avoid problems related to the liquid phase, solid sorbents functionalized with ammine have been developed using a wide variety of different supports with the development of different types of nanomaterials and artificial nanostructures with a high surface area; several types of nanostructured substrates were used to increase specific surfaces and thus CO<sub>2</sub> absorption rate. Ammine functionalized nanocapsules were synthesized by Qi et al. (Figure 3) [9] using a polyethylene imine as amine functionalizing agent. The solid sorbent has high capture capacity and high capture rate and showed good reversibility and stability during cyclic adsorption-regeneration tests.

Several other nanostructured substrates were used to produce solid sorbents functionalized with amine groups (e.g., nanotubes derived from inorganic reagents such as titanium

dioxide [11, 12], silica [13], halloysite nanotubes [14], and carbon nanotubes [15]).

The dry alkali metal based sorbents are a popular class of solid sorbents. They chemically adsorb the CO<sub>2</sub> in the form of carbonates or bicarbonates; they are mostly Na- or K-based materials and they regenerate simply by heating. The adsorption capacity for the dry alkali sorbent can reach 80% efficiency [1]. The typical working conditions are temperature below 100°C in the presence of water [16], but a sorbent for higher temperature applications was also developed [17]. The support material for dry alkali sorbent is a fundamental issue: the proper catalytic inorganic support (AC, alumina, silica, titania, or magnesia) increases the specific surface area [18] and in some cases is the main factor responsible for the proper functioning of the sorbent [19]. Increasing adsorption capacity beyond the calculated value is reported for the case of K<sub>2</sub>CO<sub>3</sub> supported on MgO [20]. Unfortunately, the dry alkali sorbents decrease their reactivity as the number of operation cycles increases, mainly because some byproducts form. Despite the fact that the raw materials for the sorbents and their supports are cheap, the large amount of sorbent needed and the regeneration costs make this technology not always affordable.

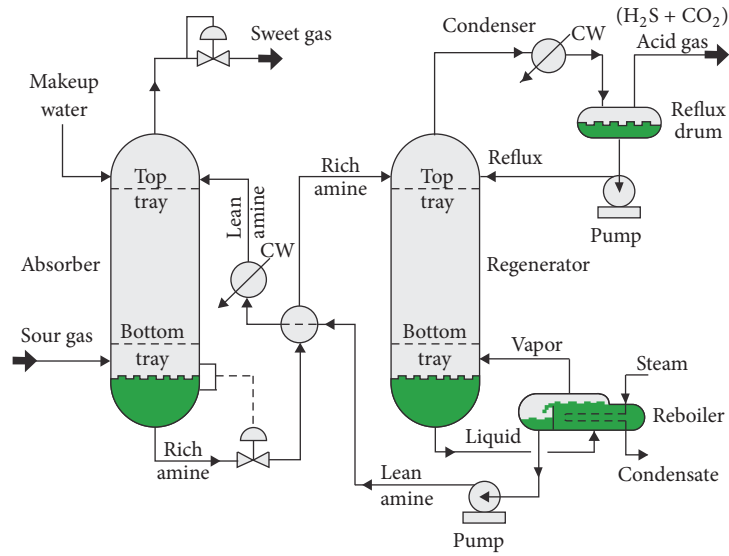

*Typical operating ranges*

Absorber: 35 to 50 °C and 5 to 205 atm of absolute pressure

Regenerator: 115 to 126 °C and 1.4 to 1.7 atm of absolute pressure at tower bottom

FIGURE 2: Flow diagram of a typical amine treating process used in industrial plants.

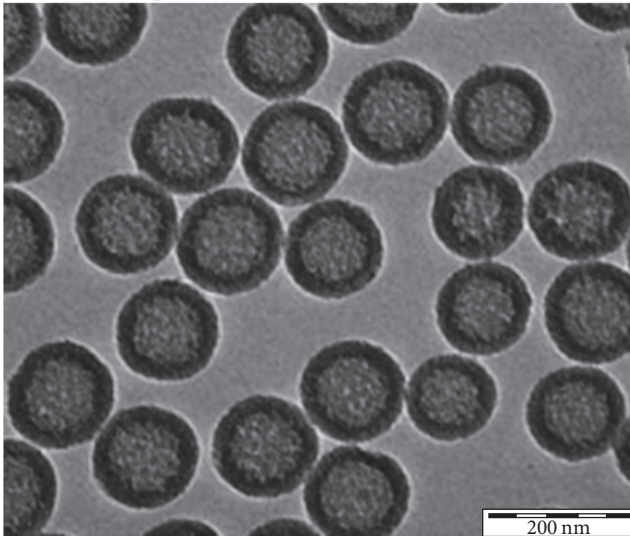
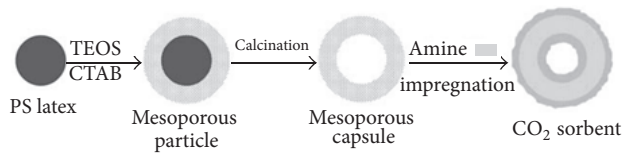

FIGURE 3: Preparation of silica mesoporous capsule starting from polystyrene nanoparticles (PS latex) using tetraethoxysilicium (TEOS) in a cetyltrimethylammonium bromide (CTAB) following calcination and impregnation with amine [9].

Nanostructured support and dry alkali can be used to partially avoid these drawbacks; for example, Valverde et al. [21, 22] support CaO on fumed nanosilica increasing the CO<sub>2</sub> capture rate by maintaining the thickness of the CaO layer

below 50 nm and thus working only on the fast superficial carbonation stage. Moreover, the loss of adsorption capacity due to sintering is reduced by the nanosilica which prevents the formation of large aggregates. Similar results were obtained by Fu et al. [23] using nanostructured layered double hydroxide supported on silica; in this case, a mesoporous structure was used as a support for the hydrothermal synthesis of LDH. Similar results were observed for alkali oxide nanoparticles stabilized by a support (Figure 4) [11]; also in this case, the small thickness enhances the CO<sub>2</sub> capture rate while CO<sub>2</sub> capture capacity is practically unchanged after many cycles.

Cryogenic separation is based on temperature drop and pressure manipulation to cause CO<sub>2</sub> liquefaction. The direct production of liquid CO<sub>2</sub> allows compression energy saving and the CO<sub>2</sub> can be stored or sequestered via liquid pumping [24]. Another advantage of cryogenic separation is the absence of chemical agents. The technology is mature; hence, operation and design feasibility can be guaranteed. However, the required energy makes the current process expensive. The other gases in the mixture with CO<sub>2</sub> (H<sub>2</sub>, N<sub>2</sub>, O<sub>2</sub>, Ar, and CH<sub>4</sub>) have relatively low boiling points that can lower the phase transition temperature of CO<sub>2</sub> even under -80 °C [25]. Finally, because of the solubility of other gases in CO<sub>2</sub>, purity might be relatively low and cannot satisfy the requirements of most industrial applications, transport, and storage [26].

If high purity of gas is not essential, membranes are a good low cost solution to separate gases. The use of membranes to separate CO<sub>2</sub> from light hydrocarbons in oil and gas and chemical industries is well known. However, there are some problems. Usually, CO<sub>2</sub> is not the main component, which means that large quantities of gases need to be processed. If flue gases are used, it is necessary to cool down the gases below 100 °C because high temperatures will rapidly degrade the membrane. The membranes will need to be resistant

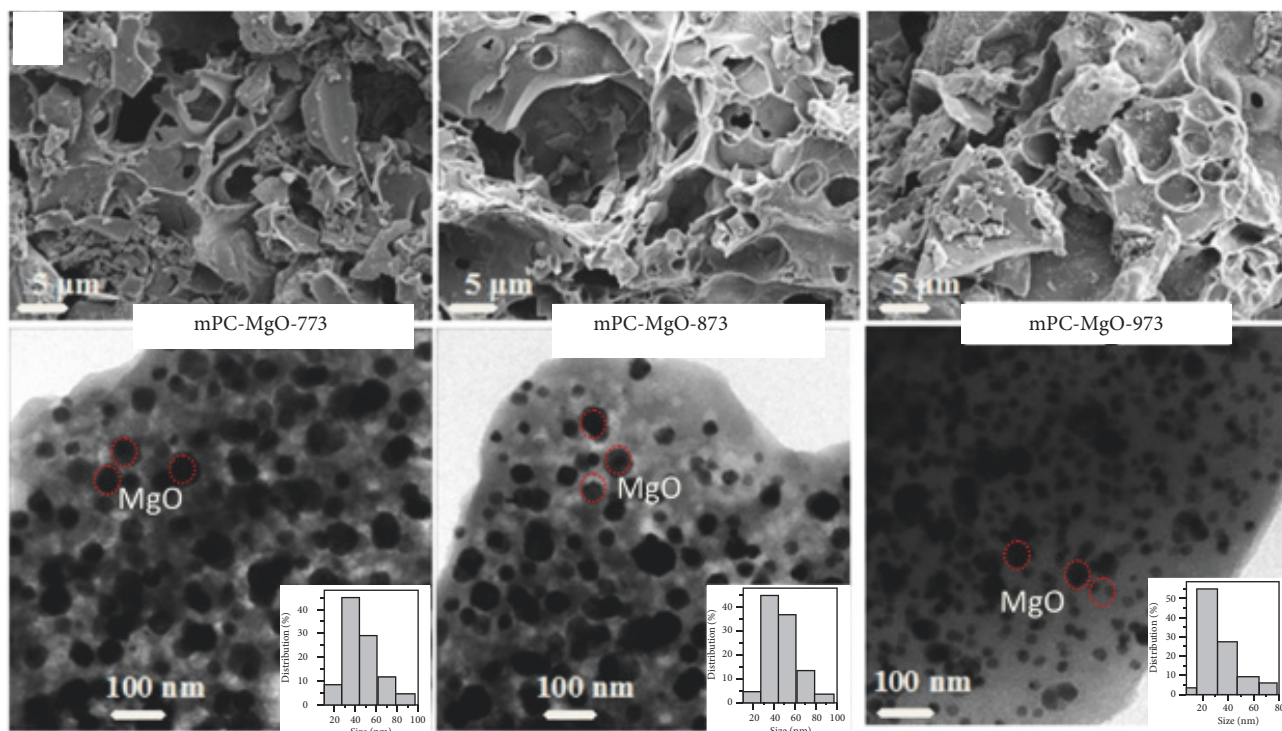

FIGURE 4: TEM images and particle size distribution (inset) of the carbon stabilized MgO NPs prepared at different temperatures [10].

to the chemicals within the gas mixture or prepreparation is necessary. Finally, pressure drop through commercial membranes requires significant amounts of power, hence reducing the energy efficiency of fuel combustion.

The use of nanostructure materials as membranes can provide a viable solution to this complex technological problem. At present, the use of nanostructured membranes is under study and in principle  $\text{CO}_2$  can be separated with only 8% of the energy produced [27]. Several nanomembranes were developed from different types of membranes, such as inorganic, metallic, polymeric, and solid/liquid types [28].

Inorganic nanoporous ceramic and metallic membranes based on steric hindrance could be used to separate  $\text{CO}_2$  directly at high temperatures. Theoretical studies have shown that nanoporous silica membranes with a thickness of 5–25 nm could achieve very high  $\text{CO}_2$  separation factors. The layers need a substrate to withstand mechanical stress.

The selectivity of polymeric membranes is directly related to the interaction with the target molecule: the different molecules can diffuse across, either by solution-diffusion or absorption-diffusion mechanisms. Combinations of  $\text{CO}_2$ -philic polymers in controlled nanofabrication conditions allow increasing the  $\text{CO}_2$  permeance by one order of magnitude in respect to classical polymeric membranes [29].

The performance of solid/liquid gas absorption membranes, which are microporous solids impregnated with an absorbent liquid, can be improved by the use of nanotechnology. In these membranes,  $\text{CO}_2$  selectively diffuses across the membrane and is captured and removed by the absorbent, obtaining microphase separation. In fact, with a

nanocorrugation of the surface, the permeability improves with respect to similar membranes [30].

Finally, nanotechnology can also be used to change by external stimuli the selectivity. E.g. Wang et al. [31] recently showed that continuous tuning of the separation ratio was possible by embedding a nanostructured metal-organic framework (MOF), assembled from a photoresponsive organic molecule, in a nanoporous membrane.

**2.4. Innovative Nanostructures Based on Solid Sorbents for  $\text{CO}_2$ .** The most promising solid sorbents for  $\text{CO}_2$  can be divided into four classes depending on the nanostructured material: porous carbon, zeolites, metal-organic frameworks, and microporous organic polymers (listed in order of maturity).

The nanostructured carbon, in the form of graphene, mesoporous carbon, and carbon nanotubes are promising solutions in  $\text{CO}_2$  adsorption. The porous carbon is so popular and interesting because of its high specific surface area and tunable porosity. It can be produced from renewable resources, the chemical functionalization is available, and regeneration is easy. However, its production and activation processes (some 600–800°C for 1–3 hours) are expensive [16]. The adsorption occurs via van der Waals forces. Regeneration is performed by simply degassing. For this reason, carbon-based sorbents lose their performance slower than other sorbent classes. The optimal operating temperature is room temperature because, at temperatures higher than 50°C, the adsorption capacity significantly decreases [32, 33]. The sorption mechanism is favored by a high partial pressure of  $\text{CO}_2$ .

Unfortunately, CO<sub>2</sub> is normally diluted in flue gas from real industrial processes and therefore the adsorption values are lower compared to laboratory data [33, 34]. Improvements in CO<sub>2</sub> uptake values can be obtained by structural and chemical modifications at nanoscale: increasing the specific surface area not always leads to the desired effect [35, 36]; on the other hand, specific nanostructures like single- and multiwalled carbon nanotubes, graphene, or microporous carbon [37] and the impregnation with ammine-containing liquid [35] or the grafting of ammine-containing functional groups [38] effectively increased efficiency.

Zeolites, due to their micro/nanoporosity, finely tunable pore size, and basicity, are widely used for gas separation and purification. They were studied for CO<sub>2</sub> adsorption in [39]. CO<sub>2</sub> molecules strongly interact with the electric field of the zeolite framework, allowing selective separation and adsorption [40]. Concerning regeneration, degassing in vacuum is the most common technique, but thermal treatments are also available [20, 41]. The increase of temperature in a limited range improves CO<sub>2</sub> uptake of the zeolites by opening the pores. Similar to the other classes, the absorption capacity increases as the partial pressure of CO<sub>2</sub> increases, while the presence of water in the flue gas, very common in industrial flue gas, decreases the performance. Nowadays, zeolites already find application in some industrial fields; they still need optimization for the large-scale adsorption of CO<sub>2</sub> focusing on some important factors such as pore size, basicity, and the presence of cation species.

A recent class of sorbents is the metal-organic framework (MOF). The MOFs are a hybrid micro/nanoporous and crystalline material, whose structure is a regular coordination network where the metal center vertices are connected by organic linkers [42]. By changing the dimension of the metal center and the organic linker, the structure of the MOFs can be finely tuned in the pore size and the specific surface area; in the same way, different metal centers and functionalized organic spacers tune the properties of the material. Due to their nanostructure and the very high surface area [43], the MOFs are widely used for gas separation [44] and storage. CO<sub>2</sub> adsorption occurs onto both the metal centers and the organic linkers inside the MOFs. The MOFs adsorption capacity increases with pressure [45], whereas it decreases with temperature. At atmospheric pressure and in the presence of water, their adsorption capacity is lower compared to other classes of solid sorbents. The MOFs are a promising nanomaterial with enormous potential, but important aspects such as stability and multicycle applicability must be optimized.

The last class of sorbents we wish to discuss in this paper is microporous organic polymers (MOPs). The microporous structure of the MOPs is due to the disordered network they have. Although the multistep synthesis of these sorbents requires expensive catalysts and the specific surface area rarely goes beyond 2000 m<sup>2</sup>/g, MOPs show relatively good adsorption capacity of CO<sub>2</sub> and CO<sub>2</sub> selectivity [46]. The "CO<sub>2</sub>-philic" chemical species in the MOPs, obtained during the synthesis or due to postmodification of the polymer, are the main factor responsible for their CO<sub>2</sub> adsorption

mechanism. The interaction strength with these moieties is low enough to allow the regeneration of the sorbent in vacuum conditions. Similar to MOFs, the high pressure and the absence of water improve the CO<sub>2</sub> uptake, but some cases of water-enhanced MOPs have been reported [47, 48]. The MOP sorbents are still immature for industrial applications but their versatility and the easy regeneration make them interesting candidates for future development.

*2.5. New CO<sub>2</sub> Liquid Sorbents: Ionic Liquids and Deep Eutectic Solvents.* Liquid absorption exhibits many disadvantages in CO<sub>2</sub> capture due to energy demand for the regeneration of the solvent, the induced corrosion, and the loss of the solvents because of their volatility [8]. Ionic liquids are potential alternatives to common solvents owing to their tunable chemical properties, low melting point, and negligible vapor pressure [49]. Due to its dipole, CO<sub>2</sub> is usually more soluble in ionic liquids than other common gases. Ionic liquids not functionalized with CO<sub>2</sub>-philic groups physically absorb CO<sub>2</sub>, and hence they require less energy for desorption with respect to classical amines. On the other hand, solubility is reduced and therefore higher volumes are necessary to process the same amount of gas. Another important disadvantage is the high viscosity. These drawbacks and the high prices restrict their industrial applications [50].

Deep eutectic solvents possess properties similar to ionic liquids and share many properties with them [51]. Deep eutectic solvents usually have simpler structures than ionic liquids and they can be prepared by mixing a hydrogen bond donor with a hydrogen bond acceptor in the appropriate ratios. Compared to ionic liquids, the research on their use as CO<sub>2</sub> separation solvent is still at its early stages.

CO<sub>2</sub> absorption can be increased by adding CO<sub>2</sub>-philic functional groups. Inclusion of cations and anions with appropriate functional groups can improve the interactions with CO<sub>2</sub> and results in new effective solvents. The main CO<sub>2</sub>-philic groups are fluorine atoms, amine, and carbonyl groups. Ionic liquids containing amine or carboxylate moieties are considered as chemical scrubbing solvents and have advantages for CO<sub>2</sub> separation under low pressure; amine-functionalized ionic liquids exhibit better selectivity, because the electrophilic properties of CO<sub>2</sub> functionalization of the anion part are usually more effective [50].

There is room for improvement through designing new ionic liquids and deep eutectic solvents with lower viscosity to compete with commercial amine solutions. Two methods are the most promising: (1) the use of tetracyanoborate anions, which is very promising to produce ionic liquid sorbents for the industrial gas separation process owing to its high CO<sub>2</sub> affinity, low ecotoxicity, and the low viscosity of the corresponding ionic liquids, and (2) the use of organic solvents to decrease ionic liquid viscosity and enhance both reactivity and CO<sub>2</sub> affinity.

Furthermore, only few studies on deep eutectic solvents are present in the literature, discussing their physical properties and the influence of chemical parameters, such as hydrogen bonding donor and molar ratio, on these solvent properties.

### 3. Cache (Storage): Borrowing the Technology

Once CO<sub>2</sub> has been captured, it needs to be stored, or cached, while “waiting” to be converted. To this end, knowledge from a leading-edge technology, that is, underground gas storage (UGS) technology, can be transferred to suit CO<sub>2</sub> storage. The concept of storing natural gas (a colorless, odorless, gaseous hydrocarbon) underground in geologic formations arose from the need to balance the divergence between the seasonal and daily variability of gas consumption.

The first successful underground storage of natural gas in a depleted natural gas reservoir occurred in 1915 in Ontario, Canada. The original and primary scope of underground gas storage (UGS) was the modulation of peak demand in a well-defined area and the optimization of the transport network. Storage also served to conserve some of the gas being wasted or flared during the summer months. Since then, hundreds of facilities have been developed: North America concentrates more than two-thirds of the sites, with over 400 storages in the US and some 60 reservoirs in Canada; Europe holds the second rank in terms of the number of facilities with over 140 facilities, followed by the Commonwealth of Independent States (CIS) with more than 50 facilities, Asia-Oceania with around 20 sites, and finally one site in Argentina and one in Iran [52]. Not surprisingly, underground storage of natural gas has become a large and essential part of the natural gas delivery system [53–55].

Underground gas storage may also be defined as the long-term safe isolation of natural gas within geological formations. Thus, two of the most important characteristics of underground storage are its capability to hold natural gas for future use and the rate at which gas can be withdrawn. The amount of gas that can be injected and withdrawn during a normal cycle of the storage is called working gas (or top gas); the remaining gas in the reservoir is referred to as base gas (or cushion gas) and it must ensure sufficient pressure to provide the required delivery rates. Because the base gas remains in the reservoir during the whole life of the UGS, unequivocally, it is part of the investment to develop the facility. If many critics have argued that one of the features of the petroleum industry is its inability to self-adjust, the current situation may very well be the moment to prove those critics wrong (at least to some extent). Consequently, it seems fitting for the industry to offer and share all its knowledge of underground gas storage to pursue CO<sub>2</sub> reduction for a greater good.

Depleted gas and oil reservoirs, deep saline formations, salt caverns, and unminable coal beds are the favorite candidates for safe geological storage of natural gas, but several reconditioned mines are also in use as gas storage facilities (Figure 5).

Historically, depleted gas or partially depleted gas reservoirs (fields located deep underground where most of the recoverable reserves have been extracted) have been the most sizeable and commonly used formations for natural gas storage. A depleted field typically represents the most suitable option because of its ability to contain and trap gas (in layman's terms, the reservoir has contained gas on a geological timescale and hence it should be capable of doing so again). A reservoir is constituted by a porous rock

bounded upwards by a sealing cap rock which prevents vertical migration, and pressure is used to force the gas into and out of the rock. A remarkable advantage of depleted fields is the level of knowledge already gained and readily available: information about the geological, structural, and petrophysical characteristics and about the fluid-flow properties is inherited from the exploration and primary production phases. Thus, system uncertainties are reduced in number and mitigated, with significant economic and technical benefits [57]. From a commercial standpoint, depleted reservoirs can typically provide very good storage efficiency in terms of both seasonal movable gas volume (i.e., the working gas) and high peak performances (i.e., injection/withdrawal gas rates). Good production rates would be guaranteed when the time comes to produce back the CO<sub>2</sub> for conversion if CO<sub>2</sub> is stored in depleted reservoirs.

Deep saline aquifers represent a common alternative for UGS. Economically speaking, aquifers cost the most to develop and operate. The major costs are due to the large cushion gas requirements and to the need of verifying the reservoir's capability to contain gas. Furthermore, the development and management of saline aquifers require that the original formation pressure is exceeded so as to displace the water initially saturating the pores of the rock and accommodating the gas; this obviously implies higher costs to inject gas whether it is natural gas or CO<sub>2</sub> in the underground.

Salt caverns and excavated caverns within rocks such as coal and granite are generally developed in regions where reservoirs are not available. They are typically used to meet peak load demands as they can contain much smaller volumes than depleted reservoirs and aquifers but can provide high delivery rates [54].

*3.1. Current CO<sub>2</sub> Storage Sites Worldwide.* Over the last decade, efforts have been intensified in different parts of the world to prove the capability of geologic storage and technologies for future long-term CO<sub>2</sub> storage, in part fueled by groups such as the Intergovernmental Panel on Climate Change (IPCC). The main large-scale CO<sub>2</sub> storage sites around the world are the Sleipner CO<sub>2</sub> Storage Site in Norway, the Weyburn-Midale CO<sub>2</sub> Project in Canada, and the In Salah Project in Algeria [58–62]. Each of these projects stores more than 1 million metric tons of CO<sub>2</sub> per year. Large-scale efforts are also currently underway in China, Australia, and Europe. The aforementioned projects together with some other 20 pilots around the world, such as the CCS pilot installation in the Lacq Basin, southwestern France [63], are demonstrating that CO<sub>2</sub> can be safely stored.

*3.2. Reservoir Engineering Knowledge Transfer from Oil and Gas Exploration and Production to UGS to CO<sub>2</sub> Storage.* Each type of UGS has its own physical characteristics and economics; thus, the development of a new UGS and the subsequent management of the overall system always require following a number of steps and actions to ensure technical feasibility, commercial value, and long-term efficiency of the project; and CO<sub>2</sub> storage projects are no different. The successful development of UGS must include an appropriate site selection based on subsurface information, but also suitable

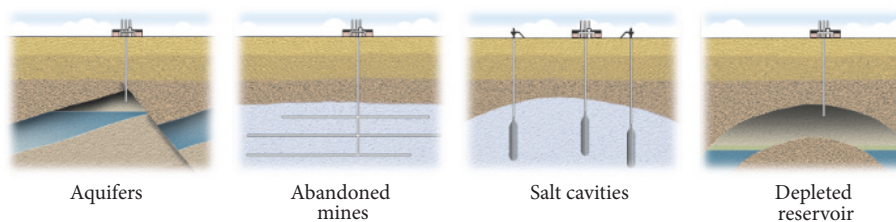

FIGURE 5: Different types of underground gas storage systems [56].

performance analysis, preferably based on a fully integrated geological, fluid-dynamic, and geomechanical approach, and eventually an adequate monitoring program to satisfy domestic technical and safety regulations together with social and environmental concerns [64, 65]. Injecting gas into an aquifer substantially calls for the same procedure except that the initial formation pressure needs to be exceeded to displace water and accommodate gas. Delta-pressuring (i.e., operating the storage at a maximum working pressure above the initial formation pressure) is a common option to enhance the performance of UGS, especially in terms of working gas. At present, dozens of UGS are operated under delta-pressure conditions in the US and Canada and a few in Europe. However, delta-pressuring requires additional design and monitoring when compared with a conventionally operated facility to ensure long-term feasibility of the project. To this end, the UGS industry has borrowed much of its knowledge from other industries (oil and gas exploration and production in the first place), but it has also been developing a technology of its own. In a similar way, CO<sub>2</sub> storage development has largely benefitted from the knowledge gathered throughout years of research in UGS; after all, knowledge is an ongoing process.

The efficient management of any storage system requires the definition of a reliable analysis tool, usually a 3D numerical model, which is then used to define the most viable development and operational strategy from both economic and technical standpoints. The generation of static (geological) and dynamic (fluid-flow) reservoir numerical models is a common practice in the oil industry because a tool is needed to forecast the future performance of the field. The static and dynamic approaches for UGS analysis follow the basic workflow of a standard reservoir study. Furthermore, rock mechanical features should also be incorporated together with the structural, sedimentological, petrophysical, and fluid-dynamic properties into the reservoir model so as to investigate not only single phenomena but also their mutual interactions through a coupled fluid-flow and stress/strain approach [66, 67].

For all of the above, gas storage operators have often faced the difficult task of having to find within “conventional” reservoir engineering appropriate solutions to very specific problems. Likewise, and rather obviously in fact, CO<sub>2</sub> storage operations will also encounter their very own technical and nontechnical issues which will have to be addressed accordingly (Figure 6). One of these issues that needs mentioning is geochemistry, to assess how CO<sub>2</sub> interacts with the underground rocks and fluids [68]. Technically speaking, research

on the topic has already produced meaningful results; for instance, simulation studies on the Utsira Formation at the Sleipner CO<sub>2</sub> Storage Site in Norway have indicated that the majority of the injected CO<sub>2</sub> will remain as a free gas within the reservoir [58]. Furthermore, it would also appear that, in many reservoirs (aquifers as well as depleted oil and gas fields), the injected CO<sub>2</sub> will be present principally as a supercritical fluid which means that larger amounts could take up less room. This leads us to another technical aspect being addressed: potential storage capacity which has so far been estimated with wide error margins; needless to say, the issue has raised some eyebrows [59]. As has been true for UGS technology, CO<sub>2</sub> storage-driven research will help experts with the efficient management of the system.

At a nontechnical level, economics seem to be the main barrier to the deployment of the technology insofar as there is no value for stored CO<sub>2</sub>. The current use of CO<sub>2</sub> in enhanced oil recovery processes makes it a commodity with value above the ground. However, the possibility of converting it into CH<sub>4</sub> (a very profitable commodity we may add) might just be the right incentive for companies to consider investing in CO<sub>2</sub> storage operations. Would not this be like killing two birds with one stone?

#### 4. Conversion: What the Future Holds

The conversion of CO<sub>2</sub> into new chemicals and fuels is a long-term solution for the global warming issue. Converting CO<sub>2</sub> could produce carbon-neutral renewable fuels whereas synthesizing multicarbon chemicals from the CO<sub>2</sub> could enable the sustainable production of precursors and feedstocks for organic synthesis [70]. CO<sub>2</sub> is a convenient starting product for the synthesis of many kinds of molecules. Over the last years, many studies have been published on the application of CO<sub>2</sub> in industrial applications. Nanotechnology has several advantages over traditional approaches to effectively convert CO<sub>2</sub>. The large surface area of nanostructured materials allows higher ratios of surface/volume, thus increasing the effectiveness of catalysis. More surface means increased adsorption, a large number of active sites, and an increase of reaction velocity.

##### 4.1. CO<sub>2</sub> Used as Building Block without Chemical Reduction.

Even if the direct use of CO<sub>2</sub> without reduction is relatively easy, it is not the ultimate solution for CO<sub>2</sub> reuse due to the low needs of the market; it is interesting at least to sketch the framework. The synthesis of urea represents one example of converting CO<sub>2</sub> into value-added products without chemical

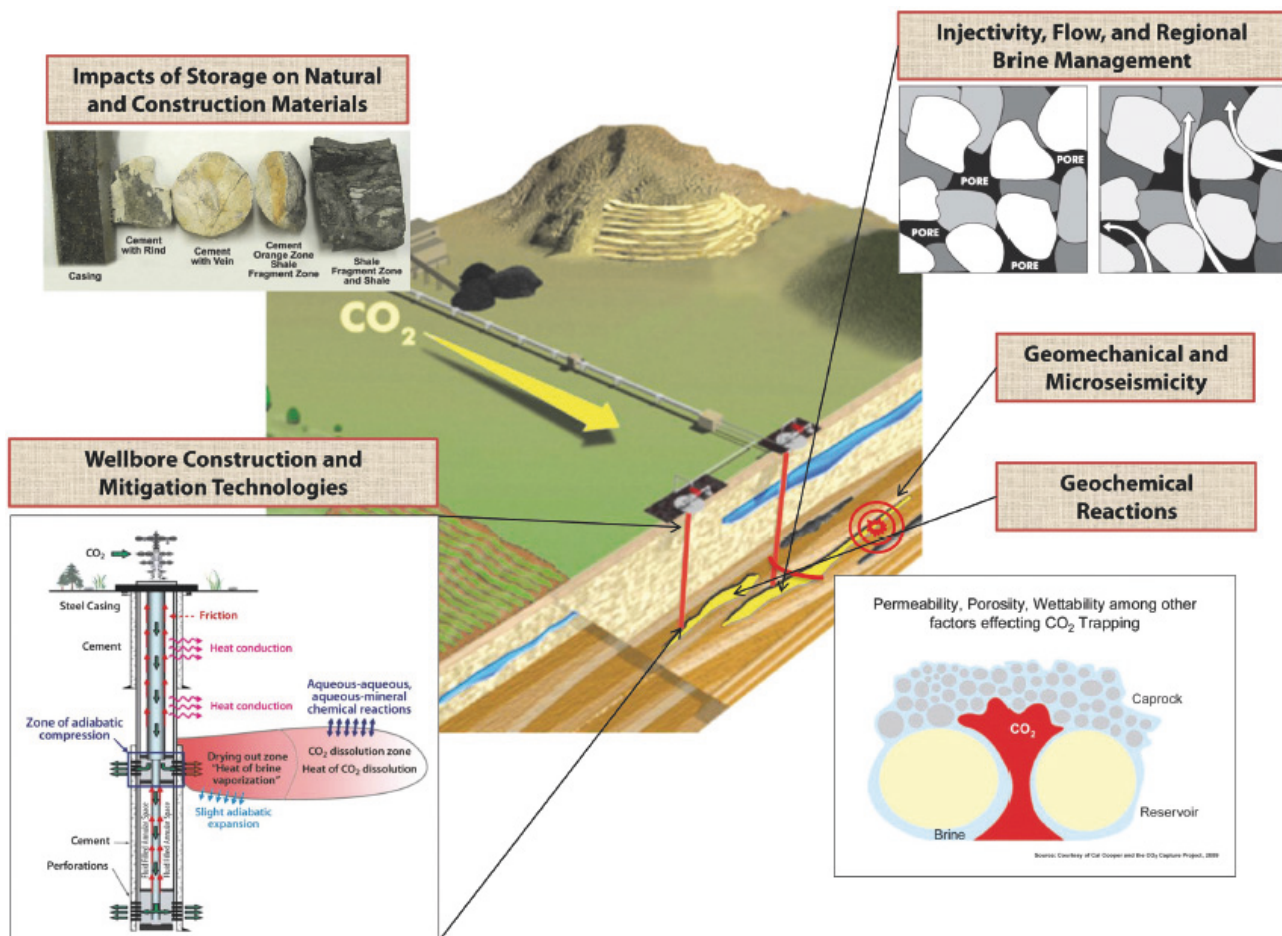
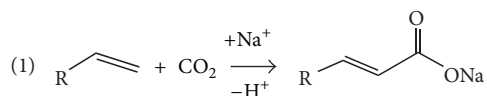
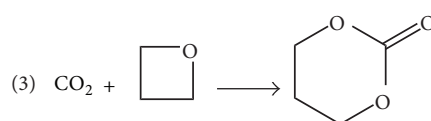
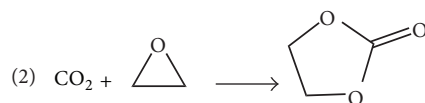

FIGURE 6: CO<sub>2</sub> geologic storage [69].FIGURE 7: Direct synthesis of acrylates from CO<sub>2</sub>.FIGURE 8: Reaction of oxetanes (2) and oxiranes (3) with CO<sub>2</sub>.

reduction and thus using reaction with a relatively low energy cost. Urea is used in fertilizers and melamine synthesis. Urea is also used in polymer synthesis such as urea-formaldehyde-melamine resins and in isocyanate-free synthesis of urethanes or carbonates in which it can be considered as an active form of CO<sub>2</sub> [71]. Another pathway to use CO<sub>2</sub> as building block is the incorporation in organic compounds such as carboxylic groups. In this case, the most studied reaction is the incorporation of CO<sub>2</sub> to form acrylates. Several catalytic pathways are known for the synthesis of acrylic acid and derivatives from CO<sub>2</sub>. Recently, a one-pot synthesis was achieved using nickel catalyst [72] (Figure 7).

CO<sub>2</sub> can substitute the phosgene also in the production of isocyanates by direct synthesis with amines using transition-metal organometallics like uranium(V) or titanium(IV) [72, 73].

The previously produced urea is also a convenient precursor of the synthesis of solvents such as cyclic carbonates. By reaction of urea with 1-2- and 1-3-diols [74, 75], ethylene carbonate and propylene carbonate were produced while ammonia was recovered for further production of urea. CO<sub>2</sub> can be used directly for the previous synthesis and thus it is becoming an industrially viable alternative to toxic phosgene in the direct reaction of CO<sub>2</sub> with ethylene oxide or the synthesis of ethylene carbonate. In fact, the reaction of CO<sub>2</sub> with oxetanes rather than oxiranes is highly selective and with high yield in the cyclic carbonates synthesis [70] (Figure 8).

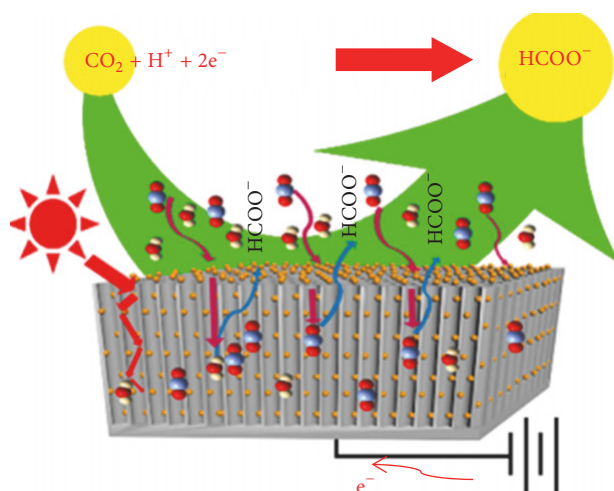

FIGURE 9: Schematic representation of photoelectrocatalytic reduction of  $\text{CO}_2$  by  $\text{Co}_3\text{O}_4$  nanotubes decorated by metallic copper nanoparticles.

The selectivity in the production of cyclic carbonates can be further improved by the use of nanotechnologies and several nanostructured materials. Graphene oxide together with an appropriate cocatalyst was found to have high yields and reaction rates in relatively mild conditions [78, 79]. Also, nanoparticles of crosslinked polymers with basic functionalities were found to improve the cyclization reaction [80–82]. In particular, it was found that polymer nanoparticles containing imidazolium groups were able to convert epoxides with 100% selectivity and high yields to cyclic carbonates [81].

#### 4.2. $\text{CO}_2$ Conversion to Lower Oxidation Carbon Compounds.

Although a certain amount of  $\text{CO}_2$  can be used directly, the amount of  $\text{CO}_2$  convertible without reduction is relatively low and it is not the ultimate solution for  $\text{CO}_2$  conversion and reuse [83]. Nonetheless,  $\text{CO}_2$  reduction requires a reduction agent with high chemical potential, such as  $\text{H}_2$  or  $\text{CH}_4$ , or an energetic source, as heat, electrons, or radiation. The reduction of  $\text{CO}_2$  is mainly used to produce fine chemicals and fuel, but the demand of fine chemicals is not large enough to be considered as a viable solution to reduce the total amount of the emitted  $\text{CO}_2$ . For this reason, fuel and power plants should be considered [84].

The current efforts in  $\text{CO}_2$  reduction lie in the development of highly active, selective, and stable catalysts, divided into two categories: electrochemical and thermal reduction of  $\text{CO}_2$ .

The electrochemical reduction of the  $\text{CO}_2$  can operate on a smaller scale and is suitable for localized  $\text{CO}_2$  conversion, since the required electricity can be obtained at a low cost from renewable energy sources. Several nanostructured catalysts are able to electrochemically reduce  $\text{CO}_2$  in aqueous electrolytes. Gold electrocatalysts can produce carbon monoxide with high efficiency [85]. The production of nanostructured materials allows the use of less expensive metals (e.g., silver, a promising material) [81]. In fact, metal [86] was used to produce a nanoporous silver (np-Ag)

catalyst able to reduce  $\text{CO}_2$  electrochemically to CO in an efficient and selective way [87]. Nanostructuring of other metals such as gold was also studied both theoretically and practically, and it was proved that the increase of concentration of alkali cations due to manipulation of electric field allows an increase in electrocatalytic  $\text{CO}_2$  reduction [88]. Another route is the production of formate/formic acid. An efficient method for the generation of alkali metal formates by electrochemical reduction of  $\text{CO}_2$  was demonstrated [89]. The alkali metal formate salts may be converted into formic acid by either electro dialysis or electrochemical acidification. Another interesting route is the production of oxalate. It is possible to synthesize oxalic acid rather than formic acid with a high energy efficiency. The electrochemical reduction of the  $\text{CO}_2$  to oxalate was patented by LiquidLight [83]. The stability is low. So, new approaches in electrocatalysts must be used to improve performance and stability. Recently, a direct synthesis of formic acid was performed by the use of nanostructured materials;  $\text{Co}_3\text{O}_4$  nanotubes obtained by electroerosion of cobalt were decorated with copper nanoparticles (Figure 9) to obtain efficient photoelectron catalysis for the selective production of formic acid by reduction of  $\text{CO}_2$  [90].

The thermal reduction of  $\text{CO}_2$  can be achieved by using methane and other derivatives. But it is not of interest since methane can be considered by itself as a fuel with a stable technology development and its use in conversion of  $\text{CO}_2$  will only produce a net loss of energy. On the other hand, the direct use of hydrogen, especially if it comes from renewable sources, as a reduction agent can be seen as a breakthrough technology for hydrogen storage and transport.

The reduction of  $\text{CO}_2$  with hydrogen results in three classes of products: formic acid and its derivatives (e.g., methanol), CO, and hydrocarbons.

One of the most investigated reactions is the hydrogenation of  $\text{CO}_2$  by nanostructured transition-metal catalysts towards formic acid or its derivatives. The reaction is carried out in organic solvent, water, and ionic liquid or directly in supercritical  $\text{CO}_2$ . The Ru- and Rh-based systems were found to be active catalysts in both aqueous media and organic solvents. Generally, the production of the formic acid is mediated by an amine which converts the acids into ammonium formate-like reaction intermediates [91, 92]. Methanol is one of the most interesting products in terms of large  $\text{CO}_2$  conversion volumes. Although the technical feasibility of such large production was not demonstrated, it appears more realistic to implement it than other possible alternatives. In fact, methanol production from  $\text{CO}_2$  and renewable  $\text{H}_2$  resources was applied in a large pilot plant [93].

CO can be produced by reverse water-gas shift (RWGS) using hydrogen produced preferably by renewable resources. The RWGS transforms  $\text{CO}_2$  and hydrogen into water and CO. The CO can be used in both synthesis of methanol and downstream Fischer-Tropsch (FT) for chemicals and fuels. The RWGS is an endothermic process, which requires high temperatures, and the conversion is equilibrium limited. The efforts on process development must focus on the optimization of active catalysts to contrast the slow kinetics and to ensure that the CO is produced at the maximum possible yield [94]. Recently, nickel supported on nanostructured

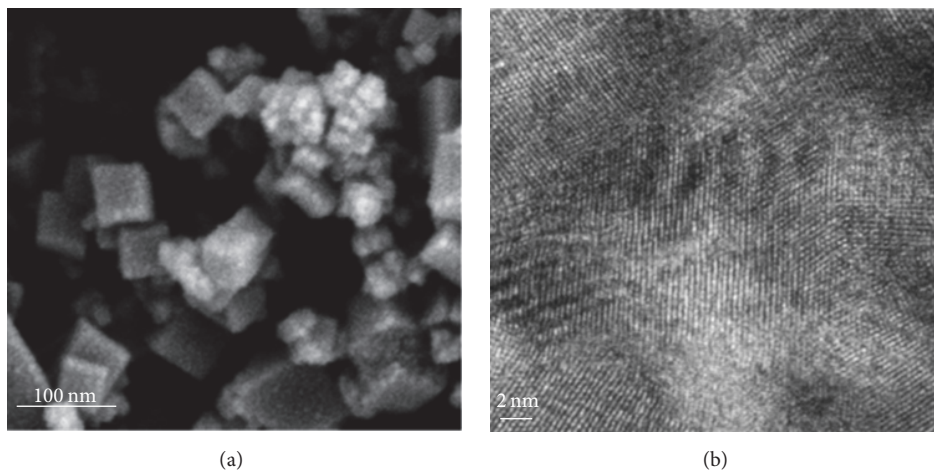

FIGURE 10: (a) Nickel supported on ceria nanocube [76]. (b) Nickel oxide nanoparticle dispersed inside mesoporous ceria [77].

oxides such as cerium oxides nanocubes [76] or mesoporous cerium oxide [77] (Figure 10) was studied as a promising material to overcome the previous problems, combining the good performance as hydrogenation catalyst of nickel with the oxygen coordination capability of ceria.

The hydrogenation of  $\text{CO}_2$  can directly lead to the production of hydrocarbons. The hydrogenation of  $\text{CO}_2$  to  $-\text{CH}_2-$  species is possible through dissociative adsorption followed by hydrogenation, but the extent to which this occurs is not well known [95]. Another possibility is direct FT reaction from  $\text{CO}_2$  and  $\text{H}_2$  performed via the RWGS followed by FT in a single reactor, which is thermodynamically easier than the RWGS because the overall process is exothermic [95]. The  $\text{CO}_2$ -FT process is very attractive because it provides a way to directly produce alkanes and olefins from  $\text{CO}_2$  and  $\text{H}_2$ , but designing the catalysts with high olefin selectivity that is water resistant is challenging. Out of the three  $\text{CO}_2$  conversion processes mentioned,  $\text{CO}_2$  hydrogenation to long-chain hydrocarbons is the least studied and characterized process. Recently a nanostructured  $\text{Fe}_2\text{O}_3$  material prepared by template-assisted synthesis shows improved conversion and selectivity [96] but we are at the early beginnings of the industrial development of these reactions.

## 5. Conclusion

As a highly policy-dependent topic, it is hard to imagine the future of  $\text{CO}_2$  emissions. What we have done is describe the efforts made to address the issue from a factual viewpoint. Authors have presented an overview of technologies, readily or soon to be available, that when properly combined could potentially offer a valid way to *reduce, reuse, and recycle*  $\text{CO}_2$ . As we have evidenced, all the possible solutions include nanomaterials and nanostructures as a promising path towards future solutions. Tentatively, the process would involve  $\text{CO}_2$  capture, cache, and conversion, coined in this text as the three Cs. In terms of  $\text{CO}_2$  capture, technologies relying on innovative solid or liquid sorbents would allow removing

$\text{CO}_2$  by producing a stream of pure  $\text{CO}_2$  as the output for storage in underground geological formations. The cache stage uses leading-edge UGS technology as a  $\text{CO}_2$ -ready-to-use-when-ready bank for conversion. The final stage, still bleeding edge though, moves towards efficient conversion of  $\text{CO}_2$  into  $\text{CH}_4$  in the attempt to support the process of transitioning into a more sustainable energy society while mitigating greenhouse gases. Finally, we could argue that the first step to achieve the three Cs is to understand how the nanotechnologies can best engage with each other to create energy from waste and not the other way around.

## Conflicts of Interest

The authors declare that they have no conflicts of interest regarding the publication of this paper.

## References

- [1] J. B. Lee, C. K. Ryu, J.-I. Baek, J. H. Lee, T. H. Eom, and S. H. Kim, "Sodium-based dry regenerable sorbent for carbon dioxide capture from power plant flue gas," *Industrial and Engineering Chemistry Research*, vol. 47, no. 13, pp. 4465–4472, 2008.
- [2] H. Yang, Z. Xu, M. Fan et al., "Progress in carbon dioxide separation and capture: a review," *Journal of Environmental Sciences*, vol. 20, no. 1, pp. 14–27, 2008.
- [3] K. S. Lackner, H. Ziock, and P. Grimes, "Carbon dioxide extraction from air: is it an option?" in *Proceedings of the 24th Annual Technical Conference on Coal Utilization & Fuel Systems*, pp. 885–896, Clearwater, FL, USA, 1999.
- [4] E. S. Sanz-Pérez, C. R. Murdock, S. A. Didas, and C. W. Jones, "Direct capture of  $\text{CO}_2$  from ambient air," *Chemical Reviews*, vol. 116, no. 19, pp. 11840–11876, 2016.
- [5] E. Favre, "Carbon dioxide recovery from post-combustion processes: can gas permeation membranes compete with absorption?" *Journal of Membrane Science*, vol. 294, no. 1-2, pp. 50–59, 2007.
- [6] E. Drioli and M. Romano, "Progress and new perspectives on integrated membrane operations for sustainable industrial

- growth," *Industrial and Engineering Chemistry Research*, vol. 40, no. 5, pp. 1277–1300, 2001.
- [7] M. Simmonds, P. Hurst, M. B. Wilkinson, C. Watt, and C. A. Roberts, "A study of very large scale post combustion CO<sub>2</sub> capture at a refining & petrochemical complex," 2003, <http://www.co2captureproject.org/>.
- [8] D. Aaron and C. Tsouris, "Separation of CO<sub>2</sub> from flue gas: a review," *Separation Science and Technology*, vol. 40, no. 1–3, pp. 321–348, 2005.
- [9] G. Qi, Y. Wang, L. Estevez et al., "High efficiency nanocomposite sorbents for CO<sub>2</sub> capture based on amine-functionalized mesoporous capsules," *Energy and Environmental Science*, vol. 4, no. 2, pp. 444–452, 2011.
- [10] W.-J. Liu, H. Jiang, K. Tian, Y.-W. Ding, and H.-Q. Yu, "Mesoporous carbon stabilized MgO nanoparticles synthesized by pyrolysis of MgCl<sub>2</sub> preloaded waste biomass for highly efficient CO<sub>2</sub> capture," *Environmental Science and Technology*, vol. 47, no. 16, pp. 9397–9403, 2013.
- [11] F. Song, Y. Zhao, H. Ding et al., "Capture of carbon dioxide by amine-loaded as-synthesized TiO<sub>2</sub> nanotubes," *Environmental Technology*, vol. 34, no. 11, pp. 1405–1410, 2013.
- [12] F. Song, Y. Zhao, and Q. Zhong, "Adsorption of carbon dioxide on amine-modified TiO<sub>2</sub> nanotubes," *Journal of Environmental Sciences (China)*, vol. 25, no. 3, pp. 554–560, 2013.
- [13] Y. G. Ko, H. J. Lee, H. C. Oh, and U. S. Choi, "Amines immobilized double-walled silica nanotubes for CO<sub>2</sub> capture," *Journal of Hazardous Materials*, vol. 250–251, pp. 53–60, 2013.
- [14] H. Cai, F. Bao, J. Gao, T. Chen, S. Wang, and R. Ma, "Preparation and characterization of novel carbon dioxide adsorbents based on polyethylenimine-modified Halloysite nanotubes," *Environmental Technology (United Kingdom)*, vol. 36, no. 10, pp. 1273–1280, 2015.
- [15] F. Su, C. Lu, A.-J. Chung, and C.-H. Liao, "CO<sub>2</sub> capture with amine-loaded carbon nanotubes via a dual-column temperature/vacuum swing adsorption," *Applied Energy*, vol. 113, pp. 706–712, 2014.
- [16] M. Younas, M. Sohail, L. L. Kong, M. J. K. Bashir, and S. Sethupathi, "Feasibility of CO<sub>2</sub> adsorption by solid adsorbents: a review on low-temperature systems," *International Journal of Environmental Science and Technology*, vol. 13, no. 7, pp. 1839–1860, 2016.
- [17] R. V. Siriwardane, C. Robinson, M. Shen, and T. Simonyi, "Novel regenerable sodium-based sorbents for CO<sub>2</sub> capture at warm gas temperatures," *Energy & Fuels*, vol. 21, no. 4, pp. 2088–2097, 2007.
- [18] S.-W. Park, D.-H. Sung, B.-S. Choi, K.-J. Oh, and K.-H. Moon, "Sorption of carbon dioxide onto sodium carbonate," *Separation Science and Technology*, vol. 41, no. 12, pp. 2665–2684, 2006.
- [19] W. Dong, X. Chen, Y. Wu, C. Zhao, and C. Liang, "Carbonation characteristics of dry sodium-based sorbents for CO<sub>2</sub> capture," *Energy and Fuels*, vol. 26, no. 9, pp. 6040–6046, 2012.
- [20] A. Samanta, A. Zhao, G. K. H. Shimizu, P. Sarkar, and R. Gupta, "Post-combustion CO<sub>2</sub> capture using solid sorbents: a review," *Industrial & Engineering Chemistry Research*, vol. 51, no. 4, pp. 1438–1463, 2012.
- [21] J. M. Valverde, A. Perejon, and L. A. Perez-Maqueda, "Enhancement of fast CO<sub>2</sub> capture by a nano-SiO<sub>2</sub>/CaO composite at Ca-looping conditions," *Environmental Science and Technology*, vol. 46, no. 11, pp. 6401–6408, 2012.
- [22] P. E. Sanchez-Jimenez, L. A. Perez-Maqueda, and J. M. Valverde, "Nanosilica supported CaO: a regenerable and mechanically hard CO<sub>2</sub> sorbent at Ca-looping conditions," *Applied Energy*, vol. 118, pp. 92–99, 2014.
- [23] L. Fu, G. Qi, O. Shekhah et al., "Synthesis and carbon dioxide sorption of layered double hydroxide/silica foam nanocomposites with hierarchical mesostructure," *ChemSusChem*, vol. 7, no. 4, pp. 1035–1039, 2014.
- [24] P. W. F. Riemer and W. G. Ormerod, "International perspectives and the results of carbon dioxide capture disposal and utilisation studies," *Energy Conversion and Management*, vol. 36, no. 6–9, pp. 813–818, 1995.
- [25] C. F. Song, Y. Kitamura, and S. H. Li, "Evaluation of Stirling cooler system for cryogenic CO<sub>2</sub> capture," *Applied Energy*, vol. 98, pp. 491–501, 2012.
- [26] G. Xu, H. Jin, Y. Yang, L. Duan, W. Han, and L. Gao, "A novel coal-based hydrogen production system with low CO<sub>2</sub> emissions," *Journal of Engineering for Gas Turbines and Power*, vol. 132, no. 3, Article ID 031701, 2010.
- [27] L. Cuffe, J. M. Don MacElroy, M. Tacke, M. Kozachok, and D. A. Mooney, "The development of nanoporous membranes for separation of carbon dioxide at high temperatures," *Journal of Membrane Science*, vol. 272, no. 1–2, pp. 6–10, 2006.
- [28] R. Baltus and D. DePaoli, "Separation of CO<sub>2</sub> using room temperature ionic liquids," in *Oak Ridge National Laboratory Environmental Sciences Division Carbon Management Seminar Series*, Oak Ridge, TN, USA, 2002.
- [29] W. Yave, A. Car, J. Wind, and K.-V. Peinemann, "Nanometric thin film membranes manufactured on square meter scale: ultra-thin films for CO<sub>2</sub> capture," *Nanotechnology*, vol. 21, no. 39, Article ID 395301, 2010.
- [30] W. Yave, A. Car, and K.-V. Peinemann, "Nanostructured membrane material designed for carbon dioxide separation," *Journal of Membrane Science*, vol. 350, no. 1–2, pp. 124–129, 2010.
- [31] Z. Wang, A. Knebel, S. Grosjean et al., "Tunable molecular separation by nanoporous membranes," *Nature Communications*, vol. 7, article 13872, 2016.
- [32] J. M. de Andrés, L. Orjales, A. Narros, M. D. M. de la Fuente, and M. E. Rodríguez, "Carbon dioxide adsorption in chemically activated carbon from sewage sludge," *Journal of the Air & Waste Management Association*, vol. 63, no. 5, pp. 557–564, 2013.
- [33] M. G. Plaza, C. Pevida, B. Arias et al., "Development of low-cost biomass-based adsorbents for postcombustion CO<sub>2</sub> capture," *Fuel*, vol. 88, no. 12, pp. 2442–2447, 2009.
- [34] A. Arenillas, K. M. Smith, T. C. Drage, and C. E. Snape, "CO<sub>2</sub> capture using some fly ash-derived carbon materials," *Fuel*, vol. 84, no. 17, pp. 2204–2210, 2005.
- [35] M. M. Maroto-Valer, Z. Tang, and Y. Zhang, "CO<sub>2</sub> capture by activated and impregnated anthracites," *Fuel Processing Technology*, vol. 86, no. 14–15, pp. 1487–1502, 2005.
- [36] P. Manoj Kumar Reddy, K. Krishnamurthy, S. K. Mahammadunnisa, A. Dayamani, and C. Subrahmanyam, "Preparation of activated carbons from bio-waste: effect of surface functional groups on methylene blue adsorption," *International Journal of Environmental Science and Technology*, vol. 12, no. 4, pp. 1363–1372, 2015.
- [37] C.-H. Yu, C.-H. Huang, and C.-S. Tan, "A review of CO<sub>2</sub> capture by absorption and adsorption," *Aerosol and Air Quality Research*, vol. 12, no. 5, pp. 745–769, 2012.
- [38] L. Zhao, Z. Bacsik, N. Hedin et al., "Carbon dioxide capture on amine-rich carbonaceous materials derived from glucose," *ChemSusChem*, vol. 3, no. 7, pp. 840–845, 2010.

- [39] T. Inui, Y. Okugawa, and M. Yasuda, "Relationship between properties of various zeolites and their CO<sub>2</sub>-adsorption behaviors in pressure swing adsorption operation," *Industrial and Engineering Chemistry Research*, vol. 27, no. 7, pp. 1103–1109, 1988.
- [40] T. D. Pham, R. Xiong, S. I. Sandler, and R. F. Lobo, "Experimental and computational studies on the adsorption of CO<sub>2</sub> and N<sub>2</sub> on pure silica zeolites," *Microporous and Mesoporous Materials*, vol. 185, pp. 157–166, 2014.
- [41] V. R. Choudhary, S. Mayadevi, and A. P. Singh, "Sorption isotherms of methane, ethane, ethene and carbon dioxide on NaX, NaY and Na-mordenite zeolites," *Journal of the Chemical Society, Faraday Transactions*, vol. 91, no. 17, pp. 2935–2944, 1995.
- [42] C. Chen, Y.-R. Lee, and W.-S. Ahn, "CO<sub>2</sub> adsorption over metal-organic frameworks: a mini review," *Journal of Nanoscience and Nanotechnology*, vol. 16, no. 5, pp. 4291–4301, 2016.
- [43] R. Grüner, V. Bon, P. Müller et al., "A new metal-organic framework with ultra-high surface area," *Chemical Communications*, vol. 50, no. 26, pp. 3450–3452, 2014.
- [44] J.-R. Li, R. J. Kuppler, and H.-C. Zhou, "Selective gas adsorption and separation in metal-organic frameworks," *Chemical Society Reviews*, vol. 38, no. 5, pp. 1477–1504, 2009.
- [45] A. R. Millward and O. M. Yaghi, "Metal-organic frameworks with exceptionally high capacity for storage of carbon dioxide at room temperature," *Journal of the American Chemical Society*, vol. 127, no. 51, pp. 17998–17999, 2005.
- [46] C. F. Martín, E. Stöckel, R. Clowes et al., "Hypercrosslinked organic polymer networks as potential adsorbents for pre-combustion CO<sub>2</sub> capture," *Journal of Materials Chemistry*, vol. 21, no. 14, pp. 5475–5483, 2011.
- [47] Y. Kong, X. Shen, S. Cui, and M. Fan, "Development of monolithic adsorbent via polymeric sol-gel process for low-concentration CO<sub>2</sub> capture," *Applied Energy*, vol. 147, pp. 308–317, 2015.
- [48] Y. Fan, R. P. Lively, Y. Labreche, F. Rezaei, W. J. Koros, and C. W. Jones, "Evaluation of CO<sub>2</sub> adsorption dynamics of polymer/silica supported poly(ethylenimine) hollow fiber sorbents in rapid temperature swing adsorption," *International Journal of Greenhouse Gas Control*, vol. 21, pp. 61–71, 2014.
- [49] T. Welton, "Room-temperature ionic liquids: solvents for synthesis and catalysis," *Chemical Reviews*, vol. 99, no. 8, pp. 2071–2083, 1999.
- [50] S. Sarmad, J. Mikkola, and X. Ji, "Carbon dioxide capture with ionic liquids and deep eutectic solvents: a new generation of sorbents," *ChemSusChem*, vol. 10, no. 2, pp. 324–352, 2017.
- [51] A. P. Abbott, G. Capper, D. L. Davies, H. L. Munro, R. K. Rasheed, and V. Tambyrajah, "Preparation of novel, moisture-stable, Lewis-acidic ionic liquids containing quaternary ammonium salts with functional side chains," *Chemical Communications*, no. 19, pp. 2010–2011, 2001.
- [52] Cedigaz, Report: Underground Gas Storage in the World. Clean Coal Research Program. Carbon Storage Technology program Plan, US Department of Energy, 2013.
- [53] C. Simeoni, R. Sedlacek, W. Rokosz et al., "The underground natural gas study in Europe and in Central Asia," in *Proceedings of the Sixteenth World Petroleum Congress*, pp. 98–99, Calgary, Canada, 2000.
- [54] A. S. Lord, "Overview of geologic storage of natural gas with an emphasis on assessing the feasibility of storing hydrogen," Technical Report SAND2009-587, Sandia National Laboratories, Albuquerque, NM, USA, 2009, <http://prod.sandia.gov/techlib/access-control.cgi/2009/095878.pdf>.
- [55] American Gas Association (AGA), "Survey of Underground Storage of Natural Gas in the United States and Canada: 2010/11," 2012.
- [56] S. Cantini, W. Klopff, R. Revelant, and F. Verga, "Integrated log interpretation approach for underground gas storage characterization," in *Proceedings of the SPE EUROPEC/EAGE Annual Conference and Exhibition*, Barcelona, Spain, 2010.
- [57] D. Viberti, "A rigorous mathematical approach for petrophysical properties estimation," *American Journal of Applied Sciences*, vol. 7, no. 11, pp. 1509–1516, 2010.
- [58] J. Gale, "Geological storage of CO<sub>2</sub>: what do we know, where are the gaps and what more needs to be done?" *Energy*, vol. 29, no. 9–10, pp. 1329–1338, 2004.
- [59] F. M. Orr Jr., "Storage of carbon dioxide in geologic formations," *JPT, Journal of Petroleum Technology*, vol. 56, no. 9, pp. 90–97, 2004.
- [60] M. Blunt, "Carbon Dioxide Storage," Briefing Paper No. 4. Grantham Institute for Climate Change, Imperial College London, 2010.
- [61] S. Bachu, "CO<sub>2</sub> storage in geological media: role, means, status and barriers to deployment," *Progress in Energy and Combustion Science*, vol. 34, no. 2, pp. 254–273, 2008.
- [62] E. O. Agiaye and M. Othman, "CO<sub>2</sub> capture and usage: harnessing the CO<sub>2</sub> content in natural gas for environmental and economic gains," *Oil and Gas Facilities*, vol. 5, no. 3, 2016.
- [63] J. Monne, "The Lacq CCS pilot, a first," in *Proceedings of the International Conference on Health, Safety and Environment in Oil and Gas Exploration and Production*, pp. 1572–1584, Society of Petroleum Engineers, Perth, Australia, 2012.
- [64] C. Benetatos and D. Viberti, "Fully integrated hydrocarbon reservoir studies: myth or reality?" *American Journal of Applied Sciences*, vol. 7, no. 11, pp. 1477–1486, 2010.
- [65] V. Rocca and D. Viberti, "Environmental sustainability of oil industry," *American Journal of Environmental Sciences*, vol. 9, no. 3, pp. 210–217, 2013.
- [66] G. Codegone, V. Rocca, F. Verga, and C. Coti, "Subsidence modeling validation through back analysis for an Italian gas storage field," *Geotechnical and Geological Engineering*, vol. 34, no. 6, pp. 1749–1763, 2016.
- [67] C. Benetatos, V. Rocca, Q. Sacchi, and F. Verga, "How to approach subsidence evaluation for marginal fields: a case history," *Open Petroleum Engineering Journal*, vol. 8, pp. 214–234, 2015.
- [68] D. J. DePaolo and D. R. Cole, "Geochemistry of geologic carbon sequestration: an overview," *Reviews in Mineralogy and Geochemistry*, vol. 77, no. 1, pp. 1–14, 2013.
- [69] <https://www.netl.doe.gov/research/coal/carbon-storage/research-and-development/storage>.
- [70] M. Aresta and A. Dibenedetto, "Utilisation of CO<sub>2</sub> as a chemical feedstock: opportunities and challenges," *Dalton Transactions*, no. 28, pp. 2975–2992, 2007.
- [71] P. Ball, H. Füllmann, and W. Heitz, "Carbonates and polycarbonates from urea and alcohol," *Angewandte Chemie International Edition in English*, vol. 19, no. 9, pp. 718–720, 1980.
- [72] A. Kumar and A. G. Samuelson, "Metathesis of carbon dioxide and phenyl isocyanate catalysed by group (IV) metal alkoxides: an experimental and computational study," *Journal of Chemical Sciences*, vol. 123, no. 1, pp. 29–36, 2011.

- [73] U. J. Kilgore, F. Basuli, J. C. Huffman, and D. J. Mindiola, "Aryl isocyanate, carbodiimide, and isocyanide prepared from carbon dioxide. A metathetical group-transfer tale involving a titanium-imide zwitterion," *Inorganic Chemistry*, vol. 45, no. 2, pp. 487–489, 2006.
- [74] Q. Li, N. Zhao, W. Wei, and Y. Sun, "Synthesis of propylene carbonate from urea and propylene glycol," *Studies in Surface Science and Catalysis*, vol. 153, pp. 573–576, 2004.
- [75] J. Sun, L. Wang, S. Zhang et al., "ZnCl<sub>2</sub>/phosphonium halide: An efficient Lewis acid/base catalyst for the synthesis of cyclic carbonate," *Journal of Molecular Catalysis A: Chemical*, vol. 256, no. 1–2, pp. 295–300, 2006.
- [76] Y. Liu, Z. Li, H. Xu, and Y. Han, "Reverse water-gas shift reaction over ceria nanocube synthesized by hydrothermal method," *Catalysis Communications*, vol. 76, pp. 1–6, 2016.
- [77] B. Lu and K. Kawamoto, "Preparation of mesoporous CeO<sub>2</sub> and monodispersed NiO particles in CeO<sub>2</sub>, and enhanced selectivity of NiO/CeO<sub>2</sub> for reverse water gas shift reaction," *Materials Research Bulletin*, vol. 53, pp. 70–78, 2014.
- [78] D.-H. Lan, F.-M. Yang, S.-L. Luo, C.-T. Au, and S.-F. Yin, "Water-tolerant graphene oxide as a high-efficiency catalyst for the synthesis of propylene carbonate from propylene oxide and carbon dioxide," *Carbon*, vol. 73, pp. 351–360, 2014.
- [79] R. Luo, X. Zhou, Y. Fang, and H. Ji, "Metal- and solvent-free synthesis of cyclic carbonates from epoxides and CO<sub>2</sub> in the presence of graphite oxide and ionic liquid under mild conditions: a kinetic study," *Carbon*, vol. 82, pp. 1–11, 2015.
- [80] Y. Xiong, H. Wang, R. Wang, Y. Yan, B. Zheng, and Y. Wang, "A facile one-step synthesis to cross-linked polymeric nanoparticles as highly active and selective catalysts for cycloaddition of CO<sub>2</sub> to epoxides," *Chemical Communications*, vol. 46, no. 19, pp. 3399–3401, 2010.
- [81] Y. Xiong, Y. Wang, H. Wang, R. Wang, and Z. Cui, "Novel one-step synthesis to cross-linked polymeric nanoparticles as highly active and selective catalysts for cycloaddition of CO<sub>2</sub> to epoxides," *Journal of Applied Polymer Science*, vol. 123, no. 3, pp. 1486–1493, 2012.
- [82] Z. Yang, J. Sun, X. Liu et al., "Nano-sized polydopamine-based biomimetic catalyst for the efficient synthesis of cyclic carbonates," *Tetrahedron Letters*, vol. 55, no. 21, pp. 3239–3243, 2014.
- [83] N. Hugué, I. Jevtović, A. Gordillo et al., "Nickel-catalyzed direct carboxylation of olefins with CO<sub>2</sub>: one-pot synthesis of  $\alpha$ ,  $\beta$ -unsaturated carboxylic acid salts," *Chemistry—A European Journal*, vol. 20, no. 51, pp. 16858–16862, 2014.
- [84] E. A. Quadrelli, G. Centi, J.-L. Duplan, and S. Perathoner, "Carbon dioxide recycling: emerging large-scale technologies with industrial potential," *ChemSusChem*, vol. 4, no. 9, pp. 1194–1215, 2011.
- [85] P. Kaiser, R. B. Unde, C. Kern, and A. Jess, "Production of liquid hydrocarbons with CO<sub>2</sub> as carbon source based on reverse water-gas shift and fischer-tropsch synthesis," *Chemie-Ingenieur-Technik*, vol. 85, no. 4, pp. 489–499, 2013.
- [86] Y. Hori, *Modern Aspects of Electrochemistry*, vol. 42, Springer, Berlin, Germany, 2008.
- [87] Q. Lu, J. Rosen, Y. Zhou et al., "A selective and efficient electrocatalyst for carbon dioxide reduction," *Nature Communications*, vol. 5, article 3242, 2014.
- [88] M. Liu, Y. Pang, B. Zhang et al., "Enhanced electrocatalytic CO<sub>2</sub> reduction via field-induced reagent concentration," *Nature*, vol. 537, no. 7620, pp. 382–386, 2016.
- [89] J. L. White, J. T. Herb, J. J. Kaczur, P. W. Majsztik, and A. B. Bocarsly, "Photons to formate: efficient electrochemical solar energy conversion via reduction of carbon dioxide," *Journal of CO<sub>2</sub> Utilization*, vol. 7, pp. 1–5, 2014.
- [90] Q. Shen, Z. Chen, X. Huang, M. Liu, and G. Zhao, "High-yield and selective photoelectrocatalytic reduction of CO<sub>2</sub> to formate by metallic copper decorated Co<sub>3</sub>O<sub>4</sub> nanotube arrays," *Environmental Science & Technology*, vol. 49, no. 9, pp. 5828–5835, 2015.
- [91] J. Á. Elek, L. Nádasdi, G. Papp, G. Laurenczy, and F. Joó, "Homogeneous hydrogenation of carbon dioxide and bicarbonate in aqueous solution catalyzed by water-soluble ruthenium (II) phosphine complexes," *Applied Catalysis A: General*, vol. 255, no. 1, pp. 59–67, 2003.
- [92] Á. Kathó, Z. Opre, G. Laurenczy, and F. Joó, "Water-soluble analogs of [RuCl<sub>3</sub>(NO)(PPh<sub>3</sub>)<sub>2</sub>] and their catalytic activity in the hydrogenation of carbon dioxide and bicarbonate in aqueous solution," *Journal of Molecular Catalysis A: Chemical*, vol. 204–205, pp. 143–148, 2003.
- [93] N. Alperowicz, ChemWeek, February 22, 2010.
- [94] T. Riedel, G. Schaub, K.-W. Jun, and K.-W. Lee, "Kinetics of CO<sub>2</sub> hydrogenation on a K-promoted Fe catalyst," *Industrial and Engineering Chemistry Research*, vol. 40, no. 5, pp. 1355–1363, 2001.
- [95] G. Centi and S. Perathoner, Eds., *Green Carbon Dioxide: Advances in CO<sub>2</sub> Utilization*, John Wiley & Sons, Hoboken, NJ, USA, 2014.
- [96] M. Albrecht, U. Rodemerck, M. Schneider, M. Bröring, D. Baabe, and E. V. Kondratenko, "Unexpectedly efficient CO<sub>2</sub> hydrogenation to higher hydrocarbons over non-doped Fe<sub>2</sub>O<sub>3</sub>," *Applied Catalysis B: Environmental*, vol. 204, pp. 119–126, 2017.



**Hindawi**

Submit your manuscripts at  
<https://www.hindawi.com>

