

## Research Article

# Modeling Risk Contagion in the Venture Capital Market: A Multilayer Network Approach

X. Zhang <sup>1,2</sup>, L. D. Valdez,<sup>2</sup> H. E. Stanley,<sup>2</sup> and L. A. Braunstein<sup>2,3</sup>

<sup>1</sup>College of Communication and Transport, Shanghai Maritime University, Shanghai 201306, China

<sup>2</sup>Center for Polymer Studies and Department of Physics, Boston University, Boston, MA 02215, USA

<sup>3</sup>Instituto de Investigaciones Físicas de Mar del Plata (IFIMAR)-Departamento de Física, FCEyN, Universidad Nacional de Mar del Plata-CONICET, Funes 3350, 7600 Mar del Plata, Argentina

Correspondence should be addressed to X. Zhang; [sivaxin@bu.edu](mailto:sivaxin@bu.edu)

Received 21 April 2019; Revised 27 July 2019; Accepted 8 August 2019; Published 15 December 2019

Academic Editor: Giulio Cimini

Copyright © 2019 X. Zhang et al. This is an open access article distributed under the Creative Commons Attribution License, which permits unrestricted use, distribution, and reproduction in any medium, provided the original work is properly cited.

Venture capital plays a critical role in spurring innovation, encouraging entrepreneurship, and generating wealth. As a part of the financial market, venture capital is affected by market downturns and economic cycles, but it also creates bubbles that negatively impact the economy and social stability. Although the venture capital market is a potential source of systemic risk, there has been little study of its contagion risk mechanism, or how the failure of a single market participant can threaten systemic stability. We use a multilayer network analysis to model the risk contagion in a venture capital market when an external shock impacts a venture capital firm or start-up company in order to understand how risk can spread through connections between market participants and harm total market robustness. We use our model to describe both the direct and indirect channels in the venture capital market that propagates risk and loss. Using real data from the worldwide venture capital market, we find that the venture capital market exhibits the same “robust-yet-fragile” feature as other financial systems. The coupling effect of direct and indirect risk contagions can cause abrupt transitions and large-scale damage even when the turbulence is minor. We also find that the network structure, connectivity, and cash position distribution of market participants impact market robustness. Our study complements other emerging research on measuring systemic risk through multiple connections among market players and on the feedback risk contagion between the financial industry and the real economy.

## 1. Introduction

Start-ups positively impact economic growth and development and are essential drivers of aggregate innovation and productivity. Innovative start-ups develop products and services that often require a high initial investment in research and development [1]. Because new firms generate only limited cash flows, and their initial capital is also often limited, many start-ups must rely on funds from such external sources as venture capital agencies to survive [2]. Venture capitalists (VCs) invest in small private growth companies that have a cash flow insufficient to pay interest on debt or dividends on equity. Typically VCs invest in private companies for a period of 2–7 years prior to exit and derive their return from the capital gains in the exit transactions [3]. Many studies have found that venture capital investment is a major factor in fostering these start-ups [4–6].

At the same time, venture capital is a part of the private equity market and is thus vulnerable to broad market turbulence and economic recessions. The venture capital market is fragile to external shocks. Downturns in the financial market make it difficult for venture capital firms to raise sufficient funds or to exit start-up companies with adequate returns. Because most start-ups have negative earnings and few tangible assets, they are particularly susceptible to failure. The venture capital market also interacts with the stock market. Since 1999, venture capital has backed 60 percent of the IPOs (initial public offering) offered in the U.S. stock market [7]. Thus instability in the venture capital market can induce damage to the overall financial market and to the entire economic system.

The 2008 financial crisis elicited much research and produced a huge body of literature on the systemic risk mechanism in play when interconnected economic agents are

simultaneously affected by severe losses that then spread throughout the economic system. Systemic risk can produce a financial domino effect or failure avalanche in which even small correlated events can cause system breakdown. One of the crucial elements in the rise of so-called cascades of failures are connections between different elements of the system [8–10]. These connections may transmit negative effects from one institution to another causing great damage to the whole economy. Risk contagions among different economic agents such as banks, insurance companies, hedge funds are investigated, and the structure of financial networks is regarded as a critical component that can either attenuate or amplify systemic risk [11].

Because network science describes both the behavior of economic system participants and the relationships among them when modeling contagion mechanisms [12–15], researchers are using it to study risk propagation in such economic systems as banking networks, buyer and seller credit systems, international trade, capital markets, and stock markets [16–19]. In a network-based risk contagion analysis, vertices represent agents in economic systems and links represent interconnections among them. A basic measure that characterizes network topology is the degree distribution  $P(k)$ , which is the fraction of nodes connected to  $k$  nodes or neighbors. This function can be used to calculate the first,  $\langle k \rangle$ , and second,  $\langle k^2 \rangle$ , distribution moments that measure mean degree connectivity and degree heterogeneity, respectively. Two typical network topologies are widely used: (i) Erdős Rényi (ER) networks in which  $P(k)$  follows a Poisson distribution, and (ii) scale-free (SF) networks with  $P(k) \sim k^{-\lambda}$  with  $k_{\min} \leq k \leq k_{\max}$ , in which  $\lambda$  is a measure of heterogeneity, and  $k_{\min}$  and  $k_{\max}$  are the minimum and maximum connectivities, respectively.

There are two commonly used approaches to the modeling of risk contagion mechanism in economic systems. The first approach is epidemiological and assumes that losses propagate through a market following an epidemic disease pattern. The asset loss or liquidity shortage experienced by a financial institution or economic agent is treated as an infected state in a classical SIR (Susceptible-Infected-Recovered) model [20–24] that assumes the infection spreads with a given probability to susceptible or healthy institutions and agents. The second approach uses the overload model in which each node (each economic agent) is assigned an asset state based on its simplified balance sheet. When the asset value of the node is lower than a given critical level, it fails and transmits losses to its neighbor nodes [25–29].

In addition to the propagation mechanism, there are risk contagion channels that define which interactions and linkages among economic agents can transmit loss or risk. We classify the risk contagion channels in the current literature as either direct or indirect connections. Direct interactions occur when there are concrete economic activities among such economic agents as credit relations between banks who loan to firms and firms who borrow from banks, supply chain contracts between buyers and sellers, credit relationships in the inter-bank market, and equity holding relationships between investors and investees [10, 30–33]. Indirect interconnections occur when there are interactions among economic agents through direct relations with such common third parties as common assets,

suppliers, customers, board members, investors, and industries [34–37].

In recent years, an increasing number of researchers have discovered that they cannot sufficiently model risk contagion if they only examine single channels, an approach that produces results that are unrealistic in the financial market and economic system. They are discovering that a multilayer network is a powerful tool for analyzing how risk spreads via multiple channels. Various studies using multilayer networks to analyze systemic risk in financial markets have found that the dynamics of risk contagion in multilayer financial networks differ greatly from those in a single layer network [38–42].

Although venture capital is a strong factor in the financing and fostering of innovative firms and re-allocating capital to more productive economic sectors, little is known about the risk transmission mechanism in the venture capital market. Our goal is thus to develop a framework for modeling this risk propagation mechanism. We want to know how risk spreads through interconnected market agents and endangers total market stability when an external shock impacts a venture capital firm or a start-up company. Most prior research has focused on risk contagion within a financial market, e.g., the inter-bank market or the stock market, and has ignored feedback effects between financial markets and the real-world economy [33, 43, 44]. This approach is inadequate because systemic risk is generated in both financial markets and in the coupling effect between financial markets and the real-world economy. Thus our study complements the emerging literature on feedback risk contagions between the financial market and the real economy for the measurement of systemic risk.

We use this model to analyze how risk and loss propagates from a single failed VC or start-up company to the entire venture capital market and to start-up firms. We ask four questions.

- (i) What are the factors that cause total market robustness to be harmed when a single VC fails?
- (ii) How does the coupling effect of direct equity connections and their indirect counterparts influence affect risk contagion?
- (iii) How does the network connection structure affect risk propagation and market robustness?
- (iv) How do the cash positions of market participants affect market robustness?

## 2. Risk Contagion Mechanisms in the Venture Capital Market

Risk can take different forms in different settings, e.g., corporate risk, financial risk, technological risk, but we focus on liquidity risk, an essential concern of investors in the venture capital market and of founders of start-up companies. Prior studies claim that venture capital investment suffers from the same significant exposure to liquidity risk as public equity and other alternative asset classes [45]. Start-up businesses are often short of cash, and 29% of all start-ups fail because of that shortage.

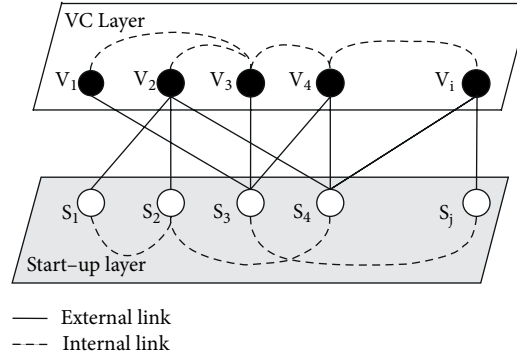

FIGURE 1: Schematic of a multilayer network to represent the risk contagion channels.

VC liquidity risk has two origins. The first is initial public offering (IPO) exit risk—being unable to effectively exit—which necessitates remaining much longer in the venture or selling the shares at a punishing discount [46, 47]. The second is related to the ability to raise funds. A VC must periodically raise funds—typically every 3 to 5 years—if it is to survive and continue to make new investments [48, 49]. The capital in the VC ecosystem is supplied by limit partners, including such large institutions as investment banks, pension funds, university and hospital endowments, charitable foundations, insurance companies, wealthy families, and corporations.

Economic downturns alter the conditions that underpin the capital supply of VC limit partners. For example, following the 2008 financial crisis, the capital commitments to U.S. venture funds fell by almost half, from 28.6 billion USD in 2008 to 15.2 billion USD in 2009 [50]. When the capital supply from the limit partner is fixed [51], the failure of one VC can cause losses to its limit partner, which in turn can transmit the decreased capital supply to unrelated VCs who share the same limit partner with the failed VC. Shocks to a liquidity supply curtail the ability of a VC to raise new funds, invest in new start-up companies, and exit successfully from prior investments.

The liquidity risk to a start-up firm increases when its cash is tied up elsewhere or when it has insufficient cash to meet working capital and expansion needs. It also has two origins. The first is that innovative start-ups often face unusually high costs of production, marketing, and branding. Just as venture capital firms must periodically raise new funds from limited partners, start-ups must periodically raise new financing from their VCs. When VCs have a shortage of capital resources it causes liquidity stress to start-ups that face rigorous competition and that must strongly finance research and development, and marketing [51]. The second origin of liquidity risk comes from the start-up ecosystem in which start-ups invest in each other. These mutual interactions create user-friendly, affordable, and innovative solutions that strengthen the market, but they also increase the risk of spillover effects. When one start-up ceases operation, other interdependent start-ups are affected.

There are thus two spread mechanisms for risk in the venture capital market—(i) direct risk that spreads through equity connections between VCs and start-ups, and (ii) indirect risk that spreads via counterpart influence relations within VCs as well as start-ups.

The contagion of direct risk via equity connections is behind the feedback damage transmitted between VCs and start-ups. For example, when an external shock hitting a VC increases the stress on its cash flow, it either quickly exits or shrinks its capital supply, which in turn damages the start-ups in its portfolio. Similarly, if a start-up fails, its venture capital investor loses the equity.

On the other hand, indirect risk propagation is the interdependency among venture capital investors and start-ups. VCs can have a co-financier relationship when two VCs have at least one common capital provider. Another indirect risk contagion channel emerges when there is an operational reliance between different start-ups.

### 3. Model

**3.1. Construct the Multilayer Network.** When quantifying the multi-dimension connections among players in the venture capital market, we first build a multilayer network  $G = \{V, S, E, I_v, I_s\}$  that represents equity connections between VCs and start-ups as well as the counterpart dependency within the venture capital industry and start-ups. Figure 1 shows the two classes of nodes, where  $V$  is the VC node set, and  $S$  is the start-up node set. Each node has a weight  $C_i$  that indicates its cash position, i.e., the amount of cash that a VC or start-up has on its books at any given time. We denote  $F(C)$  the distribution of  $C_i$ .

The external link set  $E$  is the equity connections between venture capital investors and start-ups. When venture capital investor  $v_i$  invests in start-up company  $s_j$ , a link  $E_{ij}$  connects node  $v_i$  and  $s_j$ . Here  $I_v$  and  $I_s$  both are internal link sets, where  $I_v$  is the co-funding relationship between venture capital investors, i.e., when two VCs have a common capital provider—usually limited partners—they are internally linked. Similarly,  $I_s$  is the business reliance between start-ups. The external and internal links are undirected and unweighted. Here  $k_{in}^v$  and  $k_{in}^s$  are the degree of internal links of VC and start-up nodes, respectively. Note that when  $k_{in}^v = k_{in}^s = 0$  for all nodes, the network is bipartite. Similarly,  $k_{ex}^v$  and  $k_{ex}^s$  are the degree of external links for VCs and start-ups, respectively.

**3.2. Risk Contagion Process.** The risk contagion in our model has two channels. One is direct liquidity shocks via externally linked equity connections. In our model, we select an initial

failure node from the VC or start-up layer. A failed VC node  $v_i$  transmits a shock through external links to its portfolio company  $s_j$ . This means a failed VC will reduce or withdraw the commitment of the capital supply, which in turn will increase the financial cost for a start-up company to raise capital to maintain its liquidity. At the same time, when a start-up node fails its venture capital investors still hold the start-up equity as an asset, but the equity value decreases and becomes difficult to liquidate due to a lack of buyers. To thus maintain a sufficient level of liquidity, the VC either borrows money at a very high interest or fire-sales the asset at a significant loss. Similarly, a failed start-up node  $s_j$  shocks the liquidity of its venture capital investor  $v_i$ .

Here the parameter  $D$  quantifies the level of transmitted damage caused by failed VCs or start-ups through external connection. So financially  $D$  represents the extra financial cost to VCs and start-ups needed to maintain liquidity, and this decreases its cash position. When a node receives damage through an external link, its cash position decreases  $D$ . We assume every node has an equal cash tolerance threshold  $\mathcal{C} = 0$ , i.e., for every node when  $C_i < \mathcal{C}$ , node  $i$  fails. When  $D < \min\{C_i\}$  a node fails when one external link fails because its updated cash position  $C_i - D$  remains positive, but when  $D > \max\{C_i\}$  a node fails when one external neighbor fails because its updated cash position  $C_i - D$  is now negative.

In addition to liquidity damage spreading via external links, internal links constitute another indirect risk contagion channel in the form of co-funding relationships or business reliances. Venture capital investors get their capital supply from limited partners. Limited partners usually rebalance their portfolios to stabilize their investment return. When the return of the venture capital market is lower than the limited partners expect—due to the failure of venture capital firms in their portfolio—they shrink its capital supply, which in turn causes still surviving venture capital firms in the portfolio to lose liquidity and possibly fail. So the capital supply of a VC is affected by the state of other VCs who share common limited partners. Meanwhile, small-scale start-up companies must collaborate with other start-ups who serve as suppliers and distributors, and thus their health is strongly tied to the health of their connected business partners.

Here  $T$  quantifies the two types of counterpart reliance that can spread risk. When the fraction of its failed neighbors exceeds a given threshold  $T$  in the range  $[0, 1]$ , it also fails. The lower the value of  $T$ , the more sensitive are VCs and start-ups to the state of their counterparts. We assume  $T$  to be identical for all nodes. Thus a node fails either because its current cash position  $C_i$  is lower than tolerance  $\mathcal{C}$  or the fraction of its internally linked neighbors is lower than  $T$ .

In our simulations, all VC and start-up nodes are initially assigned a cash position value  $C_1, C_2, \dots, C_N$ , where  $N$  is the system size, with a distribution  $F(C)$ . We examine three distribution functions: truncated normal, exponential, and uniform distribution. To conduct a comparison, we set the three distributions at the same mean value  $\bar{C} = 1/N \times \sum_{i=1}^N C_i$  and the low and high boundaries in the range  $[0, 10]$ . We denote these distributions  $N(\bar{C}, \sigma)$ ,  $\text{Exp}[\bar{C}]$ , and  $U[0, 10]$ .

Initially, an exogenous shock hits a targeted node in either the VC or start-up layer, and the node fails. The risk contagion dynamics then proceeds in discrete time steps  $t$ , in each of which the failure node transmits liquidity damage  $D$  to healthy neighbors via external links, and the current cash position of each healthy node is

$$C_j(t) = C_j(t-1) - D \times (k_{\text{ex}}^h(t-1) - k_{\text{ex}}^h(t)), \quad (1)$$

where  $k_{\text{ex}}^h(t)$  is the number of external links between a healthy node and its neighbor that still survive at time  $t$ . At each time step  $t$ , we test each healthy node  $j$ . If its current cash value is  $C_j < \mathcal{C}$ , the node fails. Take VC node as an example. The possibility that a VC will fail is influenced by both the number of failed start-up projects it has invested in and the initial cash value it holds. The greater the number of failed start-up companies a VC holds, the greater the probability it will fail. On the other hand, the higher the cash value it holds, the lower the probability it will fail. For the risk spread via internal links, if the fraction of its failed neighbors connected by internal links is higher than the threshold  $T$ , it also fails. The simulation stops when there are no more venture capital investors and start-up failures.

Here we quantify market robustness  $R$  to be the ratio of surviving market participants, including both venture capital investors and start-up companies [52],

$$R = \frac{N_{v^s} + N_{s^s}}{N_v + N_s}, \quad (2)$$

where  $N_{v^s}$  and  $N_{s^s}$  are the number of surviving VC and start-up nodes at the end of the risk contagion simulation, respectively. Here  $N_v$  and  $N_s$  are the sizes of VC and start-up node sets, respectively. Note that there are alternative approaches to measure system robustness and financial market systemic risk. A series of monetary measurements, including total loss level due to default, financial distress level, and total recovery cost, have also been widely used to quantify systemic risk [10, 30, 53–55].

## 4. Data

We obtain venture capital investment data from Bureau van Dijk (BVD), a leading global publisher of business information. Zephyr is the most comprehensive BVD database and contains information of over 80% of global venture investments [56]. We use a dataset from 1 January to 31 December 2017 that covers  $N_v = 7000$  venture capital firms,  $N_s = 7475$  portfolio projects, and 21116 investment events. Each investment dataset includes the name of the start-up company, the venture capital firm investing in it, and the starting date of the investment agreement. We use investment data to generate equity connections between venture capital investors and start-up companies represented by external links in the multilayer network. Figure 2 shows the degree distribution of VC nodes and start-up nodes. The degree distribution of VC nodes follows a power law decay. Thus, within 1 year, most VCs invest in a limited number of start-ups, and only a few invest in many. However, the degree distribution of the start-ups is almost unimodal, indicating that it is difficult for start-up companies

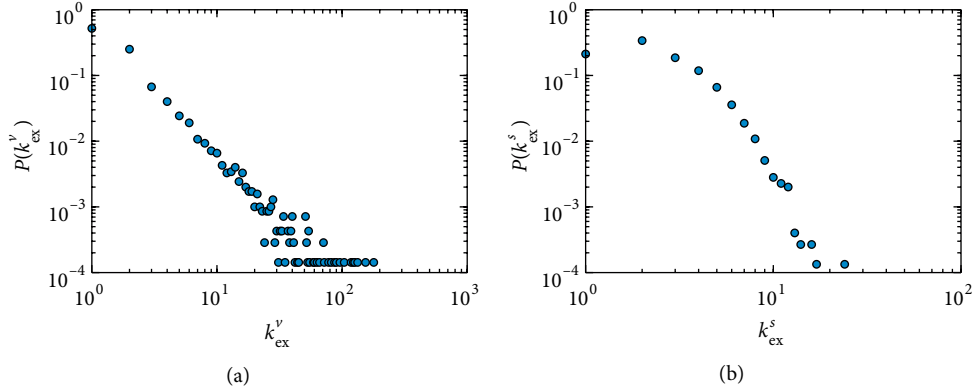

FIGURE 2: (a) External degree distribution of VC nodes ( $N_v = 7000$ ). (b) External degree distribution of start-up nodes ( $N_s = 7475$ ).

to launch a large number of financing activities within one year. The average degrees of the VC and start-up layers are 3 and 2.8, respectively.

## 5. Simulation Results

We investigate how risk propagates when a liquidity shock hits a market player, VC investor, or start-up. We select the VC and start-up nodes with the highest number of external links and examine market robustness  $R$  as a function of transmitting damage  $D$ , taking into account two risk contagion mechanisms. One only considers external links as channels for risk contagion. The other considers both external and internal links as channels for risk contagion.

Figures 3(a) and 3(b) show how market robustness  $R$  changes with an increase in  $D$  when the initially failing node is from the VC and start-up layers, respectively.

In setting up the simulation, we designate the initially failed node to be the VC or start-up node with the highest degree of external links. We select the most highly connected node to initially fail because the venture capital market functions like a nature ecosystem in which new companies compete with each other like species following the law of survival of the fittest. Thus the death of one start-up company or VC is normal and has no serious effect on system robustness. Market participants in venture capital markets and regulatory authorities are most concerned when the most highly connected companies or companies holding the largest asset fail because they want to understand how markets react when this happens and how it affects the robustness of the entire system. We currently do not have information about the asset scale of venture capital firms and start-up companies because most are private corporations with no obligation to make their financial condition public. We thus focus our attention on risk contagion when the most highly connected companies fail, which is similar to a worst-case scenario stress test conducted on the banking system.

In Figures 3(a) and 3(b),  $F(C)$  is a uniform distribution with  $C_i$  ranging from  $[0, 10]$ . The internal links within the VC and start-up layers both form an ER random network with an average degree  $\langle k_{in} \rangle = 4$  and a tolerance  $T = 0.5$ . We construct the internal networks using the configurational model [57, 58].

We find that when only external links provide the channel that propagates the losses, the venture capital market is robust. When  $D \leq 1$  the liquidity shock spreads very little. When the damage level is extremely high, e.g.,  $D = 10$ , approximately 10% players can still survive. When  $D$  increases, market robustness deteriorates linearly and gradually.

When both external and internal links affect the risk contagions, the entire market exhibits an abrupt transition. When  $D \geq 1$ , the market discontinuously transitions from a stable state in which more than 80% of the market players survive to an unstable state in which more than 90% of the market players fail. This explains why when direct and indirect risk spillover effects are present, the market becomes fragile such that the failure of a single market player at even a minor damage level can trigger the collapse of the entire market. Therefore, venture capital market exhibits the similar “robust-yet-fragile” feature as other financial systems because when only considering direct risk contagion channels, the market is robust while for direct and indirect contagion channels coupling with each other, the system is fragile. Note in the insets of Figure 3 that for the cases with internal links, the fraction of active nodes decreases abruptly at different values of  $D$  in all realizations. Heuristically, because only one node is removed at the initial condition, the point of collapse of the system is more sensitive to this initial condition since the cash position and the internal structure are random. Because the  $R$  behaviors are similar, irrespective of whether the initial shock is from the VC or start-up layer, we only examine simulation results when the initial shock hits the VC layer in following parts of our study. In Appendix B, we show the simulation results when shock hits the start-up layer.

To explore how the topology of internal links impacts on market robustness, we generate ER random and scale-free (SF) networks with the same average degree  $\langle k_{in} \rangle = 4$  for VC and start-up nodes, respectively. In addition to the topology of internal links, the initial weight distribution  $F(C)$  affects the cash flow of market players when an external shock occurs. Thus different distributions cause different levels of risk propagation.

Examining the initial cash distribution, we consider three functions, (i) truncated normal (in the range  $[0, 10]$ ), (ii) exponential, and (iii) uniform distributions, all with mean value  $\bar{C} = 5$ . At the beginning of the simulation, we fail the highest degree VC node, and the risk propagates through both internal and external links.

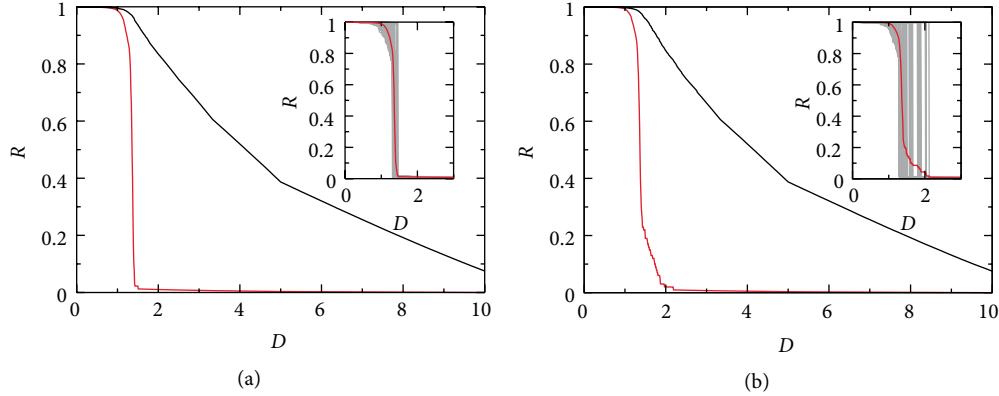

FIGURE 3: Market robustness  $R$  as the function of transmitting shock level  $D$  considering that the initial failure occurs in the VC layer (a) and in the start-up layer (b). The black curve represents the scenario only considering risk contagion via external links while the red line represents the risk propagation with internal and external link coupling effect. In each layer we use  $T = 0.5$  and internal structure topology corresponds to a random ER network with  $\langle k_{in} \rangle = 4$ . The weight follows a uniform distribution in  $[0, 10]$ . The results were averaged over 100 realizations. In the insets we show 100 individual realizations (gray) and the average curve (red).

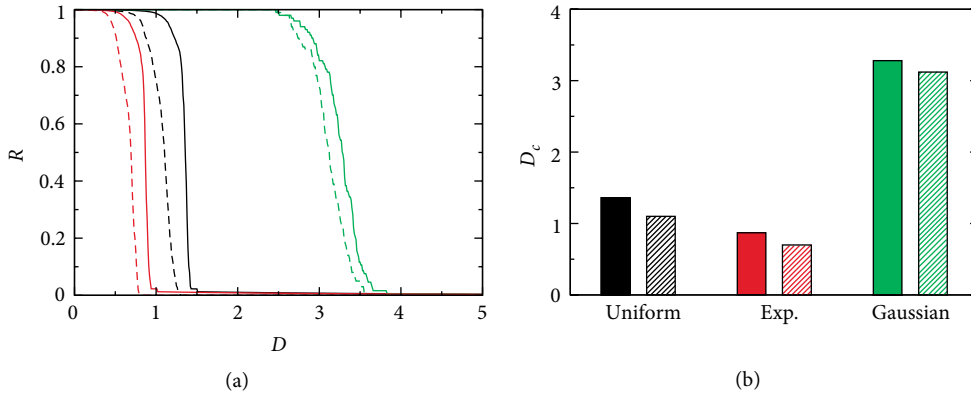

FIGURE 4: (a) Market robustness  $R$  as the function of transmitting shock level  $D$  in external and internal link coupling scenario with ER random network (solid lines) and Scale-Free network (dashed lines) for internal links, with different weight distributions: uniform  $C \sim U [0, 10]$  (black), exponential  $C \sim \text{Exp} [5]$  (red) and truncated normal  $C \sim N(\bar{C} = 5, \sigma = 1)$  in the range  $[0, 10]$  (green). Both layers have  $\langle k_{in} \rangle = 4$  and  $T = 0.5$ . For the SF network, the minimum connectivity is  $k_{min} = 2$ , the maximum connectivity  $k_{max}$  is the size of each layer, and  $\lambda = 2.65$ . The results were averaged over 100 realizations. (b) Values of  $D_c$  obtained from panel (a), for each weight distribution for ER internal networks (solid area) and SF internal networks (dashed area).

Figure 4 compares the relationship between market resilience and the level of transmitting damage  $D$  for ER and SF internal links with different distributions  $F(C)$ . We find that the market robustness in both ER and SF internal links exhibits an abrupt transition from a phase in which almost all nodes are active to a phase in which an insignificant number of nodes are active. However, when the internal links are SF, the market collapses at lower damage level, which means that at the same level damage transmission the market is more fragile with SF internal links than with ER. Note that the point  $D$  at which  $R$  abruptly transitions depends on the weight distribution  $F(C)$ .

We use  $D_c$  to quantify the level of liquidity shock when more than 50% market players survive the risk propagation. Note that the value of  $D_c$  depends on the weight distribution. A truncated normal distribution has a higher  $D_c$  value than the uniform and exponential distributions, and the  $D_c$  value for the exponential distribution is lowest. The exponential distribution of  $C$  indicates that the majority of market

participants have a low cash position, and that a few have a very high cash position. This skewness and imbalance increases market fragility such that even a minor shock to one player can trigger a collapse of the entire market.

To analyze how  $\langle k_{in} \rangle$  influences risk propagation, we use an ER network to generate internal links for both VC and start-up nodes with an average degree  $\langle k_{in} \rangle$  varying from 0 to 20.

Figure 5 compares the phase diagram of market robustness  $R$  with different  $D$  values and the average degree  $\langle k_{in} \rangle$  when  $C$  follows (a) uniform, (b) exponential, and (c)–(e) truncated normal distributions. In all cases the value of the mean weight is  $\bar{C} = 5$ . Figures 5(c)–5(e) correspond to a truncated distribution with dispersion  $\sigma = 3, \sigma = 1$ , and  $\sigma = 0$ . Note that  $\sigma = 0$  corresponds to a delta distribution.

Figure 5 shows that  $R$  exhibits similar dynamics patterns for uniform, exponential, and truncated normal distributions when  $\sigma = 1$  and  $\sigma = 3$ . When the connectivity of internal links is very small, e.g., when  $\langle k_{in} \rangle < 1$ ,  $R$  decreases slowly as  $D$

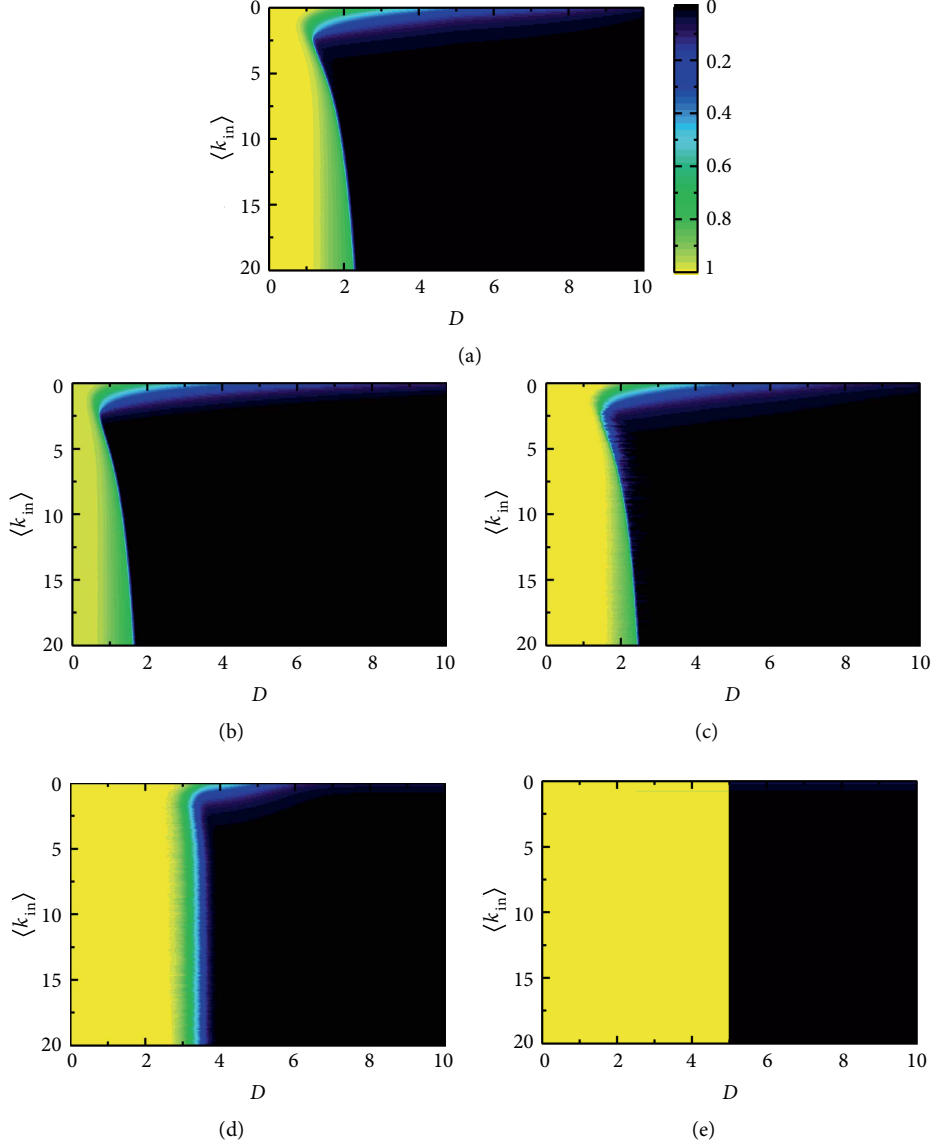

FIGURE 5: Phase diagram of the market robustness  $R$  in the plane  $D$ - $\langle k_{\text{in}} \rangle$  for  $T = 0.5$  and different weight distributions: uniform (a), exponential (b), truncated normal with dispersion  $\sigma = 3$  (c),  $\sigma = 1$  (d), and  $\sigma = 0$  (e). Yellow corresponds to  $R = 1$  and black to  $R = 0$ . For all weight distributions, the mean weight is  $\bar{C} = 5$ . The internal degree distribution corresponds to an ER network with  $\langle k_{\text{in}} \rangle = 4$ . The initial shock is in the VC layer. The results were averaged over 100 realizations.

increases, because the risk contagion effect of internal links is limited and is similar to risk spreading through external links. When connectivity is increased, the market crashes when  $D$  reaches a certain level, e.g., when  $\langle k_{\text{in}} \rangle = 2$ ,  $R$  exhibits an abrupt transition as  $D$  increases. In addition, for higher values of  $\langle k_{\text{in}} \rangle$ , market robustness still experiences an abrupt transition, but the critical  $D$  value that causes market to transition from a stable to an unstable state becomes higher. Thus when the average degree of the internal links is higher than 2, the internal links become increasingly dense, and the market can tolerate a higher level of transmitted damage.

On the other hand, for a delta distribution, i.e., when all the nodes have the same weight, the point of the abrupt transition is independent of the value of  $\langle k_{\text{in}} \rangle$ , and its position is at  $D_c = \bar{C} = 5$ . When the weight is homogeneous

( $C_i = \bar{C} = \min\{C_i\} = \max\{C_i\}$  for  $i = 1, \dots, N$ ), the critical value of  $D$  is the same as  $\bar{C}$  because:

- (i) when  $D < 5 = \min\{C_i\}$ , the failure of an initial node in one layer does not damage neighbors in the other layer—they do not fail because their cash position  $C_i - D$  is positive (see Section 3.2), and
- (ii) when  $D > 5 = \max\{C_i\}$ , the failure of an initial node can destroy the entire network because all of its nodes are fragile—if even one neighbor fails, they all fail in a domino effect (see Section 3.2).

Thus, for  $D < \bar{C}$ , since external links cannot transmit the damage (when the initial shock does not transmit the damage through internal links), the internal structure does not affect

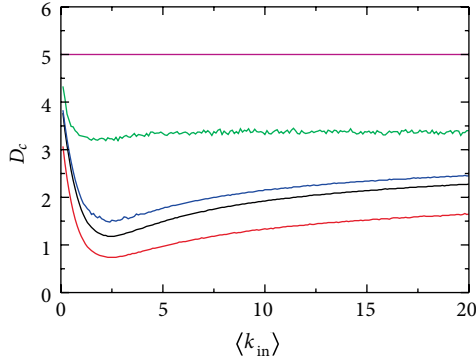

FIGURE 6:  $D_c$  as the function of average degree of internal links  $\langle k_{in} \rangle$  obtained from Figure 5 for different weight distributions: uniform (black), exponential (red), truncated normal with  $\sigma = 0$  (magenta),  $\sigma = 1$  (green), and  $\sigma = 3$  (blue).

the value of  $R$ . This behavior is in contrast to the nonhomogeneous weight in which the propagation of the failure through external links is boosted by the internal links, and hence  $R$  depends on  $\langle k_{in} \rangle$ .

Comparing the robustness of different weight distributions, Figure 6 shows a plot of  $D_c$  as a function of  $\langle k_{in} \rangle$ . We find that for all distributions of  $C$  (except the delta distribution),  $D_c$  decreases sharply when  $\langle k_{in} \rangle$  varies in the range 0–2. After  $\langle k_{in} \rangle$  surpasses 2,  $D_c$  tends to rise and causes more highly connected internal links within the VCs and the start-ups to absorb risk and increase market robustness. Note however that when the network connectivity exceeds a critical value, the risk dispersion effect caused by incrementing connectivity will be decremented. Figure 6 shows that  $D_c$  increases very slightly or remains stable for large values of  $\langle k_{in} \rangle$ . On the other hand, for the delta distribution, we find that  $D_c$  is independent of  $\langle k_{in} \rangle$  as shown in Figure 5 and the value of  $D_c$  is the highest compared to the other distributions. In addition, we observe for the other distributions that the higher the probability that a node has a low weight, the lower the value of  $D_c$ . Thus when many players or nodes have a similar cash position, the market is more robust, and the weight heterogeneity increases market susceptibility to failure cascades.

## 6. Summary and Conclusions

We have proposed a network-based risk contagion model to investigate whether the failure of one market player can negatively affect system stability. In our model, a multi-layer network is established to describe the multiple risk contagion channels in venture capital market, in which we use external links to represent the direct equity connections between venture capital industry and start-up businesses as well as internal links to represent the indirect counterpart relations within VCs and start-ups.

Using real data from worldwide venture capital markets, we simulate shocks to a venture capital firm. We evaluate how the venture capital industry and start-up business react, and how the losses are transmitted from a single element to the whole system taking into consideration two contagion mechanisms:

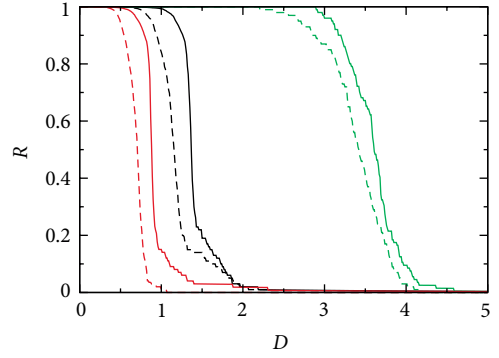

FIGURE 7: Market resilience  $R$  as the function of transmitting shock level  $D$  in external and internal link coupling scenario with ER random network (solid lines) and Scale-Free network (dashed lines) for internal links, with different weight distributions: uniform  $C \sim U[0, 10]$  (black), exponential  $C \sim Exp[5]$  (red) and truncated normal  $C : N(\bar{C} = 5, \sigma = 1)$  (green). The initial shock is in the start-up layer. Both layers have  $\langle k_{in} \rangle = 4$  and  $T = 0.5$ . For the SF network, the minimum connectivity is  $k_{min} = 2$ , the maximum connectivity  $k_{max}$  is the size of each layer, and  $\lambda = 2.65$ . The results were averaged over 100 realizations.

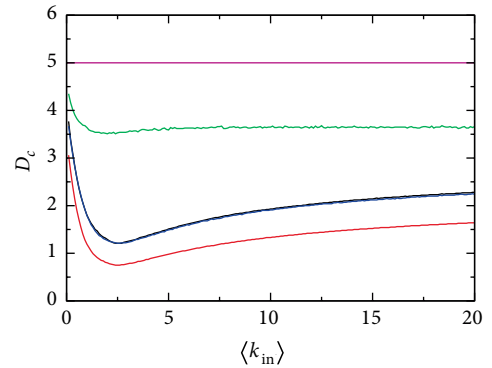

FIGURE 8:  $D_c$  as the function of average degree of internal links  $\langle k_{in} \rangle$  when the initial shock is in the start-up layer, for different weight distributions: uniform (black), exponential (red), truncated normal with  $\sigma = 0$  (magenta),  $\sigma = 1$  (green), and  $\sigma = 3$  (blue).

(i) direct propagation via equity connections between VCs and start-ups, and (ii) coupling contagions of both direct and indirect spread. We also investigate the impact of various parameters, including damage transmission level, network structure, connectivity, and the impact of the cash position distribution of market participants on market robustness.

We find that when losses propagate only via direct dependencies between VCs and start-ups, there is little damage to the venture capital market, and the system remains robust to minor turbulence. When there are both direct and indirect risk contagion channels, e.g., co-financier relationship among VCs and mutual business dependency within start-ups, the whole market becomes fragile and there is an abrupt transition from the stable to an unstable state. We also find that an SF network of internal links collapses at a lower transmitting damage level than an ER random network. The simulation results also show that increasing the connectivity increases



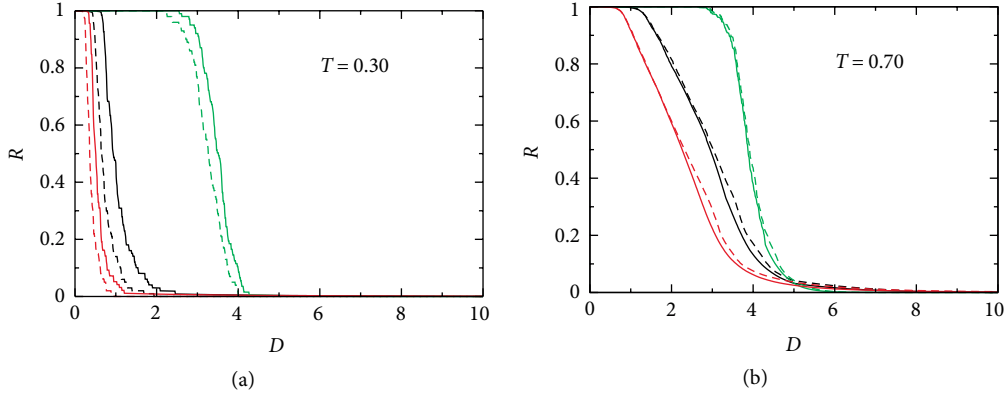

FIGURE 9: Market robustness  $R$  as the function of transmitting shock level  $D$  in external and internal link coupling scenario with ER random network (solid lines) and scale-free network (dashed lines) for internal links. Both layers have  $\langle k_{in} \rangle = 4$  and  $T = 0.30$  (a) and  $T = 0.70$  (b). We simulate different weight distributions: uniform  $C \sim U[0, 10]$  (black), exponential  $C \sim Exp[5]$  (red), and truncated normal  $C \sim N(\bar{C} = 5, \sigma = 1)$  in the range  $[0, 10]$  (green). For the SF network, the minimum connectivity is  $k_{min} = 2$ , the maximum connectivity  $k_{max}$  is the size of each layer and  $\lambda = 2.65$ . The initial shock is on the venture capital market. The results were averaged over 100 realizations.

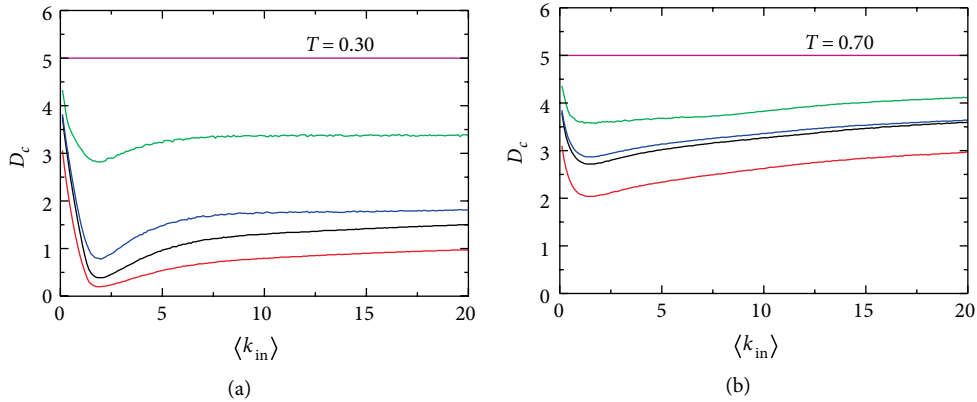

FIGURE 10:  $D_c$  as the function of average degree of internal links  $\langle k_{in} \rangle$  for  $T = 0.30$  (a) and  $T = 0.70$  (b) and for different weight distributions: uniform (black), exponential (red), truncated normal with  $\sigma = 0$  (magenta),  $\sigma = 1$  (green) and  $\sigma = 3$  (blue). The internal degree distribution corresponds to an ER network. The initial shock is on the venture capital market.

market robustness, but that when market connectivity reaches a certain value, the risk-absorbing effect becomes limited. The distribution of players' cash positions also affects the risk contagion. When the player cash positions are more homogeneous, the damage tolerance is higher, but when they are more heterogeneous—with many nodes experiencing a low cash position—the market collapses at a lower damage level. Thus heterogeneity in either the internal degree distribution or the cash position distribution increases system fragility.

Our findings increase the understanding of financial system robustness when participants interact through multiple connections. Our results indicate that only taking into consideration direct risk spillovers, the venture capital market exhibits robust stability. However, when indirect and direct risk contagion mechanisms couple together, it can be very fragile and very sensitive to a small initial failure.

This paper indicates that venture capital firm as a financial intermedia has its positive role to foster innovation by providing capital. While it also has downside effects to transmit turbulence from the financial market to the start-up economy. We show the

current approach solely considering single risk contagion channels systematically underestimate expected systemic losses. When the direct and indirect risk contagion couple together, even a mild level liquidity shortage and bankruptcy of one firm could trigger the catastrophic collapse of the venture market. This will harm the fundamentals of industrial innovation. For policy regulators, only focusing on the direct shock transmission could lead to serious bias. Currently, it lacks detailed information about the co-fund raising interconnection among venture capital firms and business reliance of start-up companies. In the future, if the government could collect and publish these data, it will be helpful to propose metrics combining direct and indirect connections to effectively measure the stability of the venture capital market.

## Appendix

### A. Shock from Start-Up Layer

In Figures 7 and 8, we show the fraction of active nodes as a function of  $D$  and the value of  $D_c$  as a function of  $\langle k_{in} \rangle$  when the initial shock

begins in the start-up layer and for different weight distributions. Figures 7 and 8 have the same qualitative behavior as Figures 4(a) and 6, respectively.

## B. Simulation Results with respect to Different Values of $T$

In Figures 9(a) and 9(b) we show the market robustness  $R$  as a function of transmitting damage  $D$  for  $T = 0.30$  and  $T = 0.70$ , and for ER and SF networks. We obtain that these figures are qualitatively similar to Figure 4. However, for  $T = 0.7$ , the market robustness for ER is similar to the case of SF which is expected because the failure probability due to the risk spread via internal links decreases as  $T$  increases, and hence the effect of internal topology becomes less relevant for the risk propagation.

Figures 10(a) and 10(b) show  $D_c$  as a function of  $\langle k_{in} \rangle$  for  $T = 0.30$  (a) and  $T = 0.70$  (b). We observe that the results shown in these figures are similar to those in Figure 6.

## Data Availability

The data used to support the findings of this study are available from the corresponding author upon request.

## Conflicts of Interest

The authors declare that there is no conflict of interest regarding the publication of this paper.

## Acknowledgments

This work was supported by the National Science Foundation of China (Grant No. 71601112) and the Shanghai Pujiang Program (Grant No. 2019PJC062). The Boston University Center for Polymer Studies is supported by NSF Grants PHY-1505000 and CHE-1856496, by DTRA Grant HDTRA1-14-1-0017. LAB thanks UNMdP and CONICET (PIP 00443/2014) for financial support.

## References

- [1] P. Aghion, R. Blundell, R. Grith, P. Howitt, and S. Prantl, "The effects of entry on incumbent innovation and productivity," *The Review of Economics and Statistics*, vol. 91, no. 1, pp. 20–32, 2009.
- [2] S. Srinivasan, I. Barchas, M. Gorenberg, and E. Simoudis, "Venture capital: fueling the innovation economy," *Computer*, vol. 47, no. 8, pp. 40–47, 2014.
- [3] D. Cumming, G. Fleming, and A. Schwienbacher, "Liquidity risk and venture capital finance," *Financial Management*, vol. 34, no. 4, pp. 77–105, 2005.
- [4] M. Peneder, "The impact of venture capital on innovation behaviour and firm growth," *Venture Capital*, vol. 12, no. 2, pp. 83–107, 2010.
- [5] S. Samila and O. Sorenson, "Venture capital, entrepreneurship, and economic growth," *Review of Economics and Statistics*, vol. 93, no. 1, pp. 338–349, 2011.
- [6] A. Popov and P. Roosenboom, "Venture capital and patented innovation: evidence from Europe," *Economic Policy*, vol. 27, no. 71, pp. 447–482, 2012.
- [7] S. J. Chang, "Venture capital financing, strategic alliances, and the initial public offerings of internet startups," *Journal of Business Venturing*, vol. 19, no. 5, pp. 721–741, 2004.
- [8] R. M. May, S. A. Levin, and G. Sugihara, "Complex systems: ecology for bankers," *Nature*, vol. 7181, no. 415, pp. 893–895, 2008.
- [9] A. G. Haldane and R. M. May, "Systemic risk in banking ecosystems," *Nature*, vol. 469, no. 7330, pp. 351–355, 2011.
- [10] S. Battiston, M. Puliga, R. Kaushik, P. Tasca, and G. Caldarelli, "Debt-rank: too central to fail? Financial networks, the fed and systemic risk," *Scientific Reports*, vol. 2, no. 8, p. 541, 2012.
- [11] S. R. S. de Souza, T. C. Silva, B. M. Tabak, and S. M. Guerra, "Evaluating systemic risk using bank default probabilities in financial networks," *Journal of Economic Dynamics and Control*, vol. 66, pp. 54–75, 2016.
- [12] S. P. Borgatti, A. Mehra, D. J. Brass, and G. Labianca, "Network analysis in the social sciences," *Science*, vol. 323, no. 5916, pp. 892–895, 2009.
- [13] A. Garas, P. Argyrakis, C. Rozenblat, M. Tomassini, and S. Havlin, "Worldwide spreading of economic crisis," *New Journal of Physics*, vol. 12, no. 11, p. 113043, 2010.
- [14] D. Y. Kenett and S. Havlin, "Network science: a useful tool in economics and finance," *Mind & Society*, vol. 14, no. 2, pp. 155–167, 2015.
- [15] B. M. Tabak, T. C. Silva, and A. Sensoy, "Financial networks," *Complexity*, vol. 2018, Article ID 7802590, 2 pages, 2018.
- [16] C.-P. Georg, "The effect of the interbank network structure on contagion and common shocks," *Journal of Banking & Finance*, vol. 37, no. 7, pp. 2216–2228, 2013.
- [17] G. Caldarelli, A. Chessa, F. Pammolli, A. Gabrielli, and M. Puliga, "Reconstructing a credit network," *Nature Physics*, vol. 9, no. 3, pp. 125–126, 2013.
- [18] M. Bardoscia, S. Battiston, F. Caccioli, and G. Caldarelli, "Pathways towards instability in financial networks," *Nature Communications*, vol. 8, Article ID 14416, 2017.
- [19] S. Battiston, D. D. Gatti, M. Gallegati, B. Greenwald, and J. E. Stiglitz, "Liaisons dangereuses: Increasing connectivity, risk sharing, and systemic risk," *Journal of Economic Dynamics and Control*, vol. 36, no. 8, pp. 1121–1141, 2012.
- [20] R. M. Anderson and R. M. May, *Infectious Diseases of Humans: Dynamics and Control*, Oxford University Press, New York, 1992.
- [21] G. Brandi, R. Di Clemente, and G. Cimini, "Epidemics of liquidity shortages in interbank markets," *Physica A: Statistical Mechanics and its Applications*, vol. 507, pp. 255–267, 2018.
- [22] M. Toivanen, "Contagion in the interbank network: an epidemiological approach," *SSRN Electronic Journal*, 2013.
- [23] N. Demiris, T. Kypraios, and L. Vanessa Smith, "On the epidemic of financial crises," *Journal of the Royal Statistical Society: Series A (Statistics in Society)*, vol. 177, no. 3, pp. 697–732, 2014.
- [24] M. Kanno, "The network structure and systemic risk in the Japanese interbank market," *Japan & the World Economy*, vol. 36, pp. 102–112, 2015.
- [25] S. Levy-Carciente, D. Y. Kenett, A. Avakian, H. E. Stanley, and S. Havlin, "Dynamical macroprudential stress testing using network theory," *Journal of Banking & Finance*, vol. 59, pp. 164–181, 2015.

- [26] J. B. R. B. Barroso, T. C. Silva, and S. R. S. de Souza, "Identifying systemic risk drivers in financial networks," *Physica A: Statistical Mechanics and its Applications*, vol. 503, p. 650, 2018.
- [27] H. Amini and A. Minca, "Inhomogeneous financial networks and contagious links," *Social Science Electronic Publishing*, vol. 64, no. 5, pp. 1109–1120, 2014.
- [28] C. D. Brummitt and T. Kobayashi, "Cascades in multiplex financial networks with debts of different seniority," *Physical Review E*, vol. 91, no. 6, p. 062813, 2015.
- [29] X. Zhang, L. Feng, Y. Berman, N. Hu, and H. E. Stanley, "Exacerbated vulnerability of coupled socio-economic risk in complex networks," *EPL (Europhysics Letters)*, vol. 116, no. 1, p. 18001, 2016.
- [30] L. Eisenberg and T. H. Noe, "Systemic risk in financial systems," *Management Science*, vol. 47, no. 2, pp. 236–249, 2001.
- [31] L. Tang, K. Jing, J. He, and H. E. Stanley, "Complex interdependent supply chain networks: cascading failure and robustness," *Physica A Statistical Mechanics and Its Applications*, vol. 443, pp. 5858–5869, 2016.
- [32] K. P. Scheibe and J. Blackhurst, "Supply chain disruption propagation: a systemic risk and normal accident theory perspective," *Social Science Electronic Publishing*, vol. 56, no. 1, pp. 1–17, 2017.
- [33] T. Lux, "A model of the topology of the bank-firm credit network and its role as channel of contagion," *Journal of Economic Dynamics and Control*, vol. 66, pp. 36–53, 2016.
- [34] F. Caccioli, M. K. Shrestha, C. Moore, and J. D. Farmer, "Stability analysis of financial contagion due to overlapping portfolios," *SSRN Electronic Journal*, vol. 46, pp. 233–245, 2012.
- [35] K. Fink, U. Krügger, B. Meller, and L.-H. Wong, "The credit quality channel: modeling contagion in the interbank market," *Social Science Electronic Publishing*, vol. 25, pp. 83–97, 2015.
- [36] T. Ahnert and C.-P. Georg, "Information contagion and systemic risk," *Journal of Financial Stability*, vol. 35, pp. 159–171, 2017.
- [37] O. Banwo, F. Caccioli, P. Harrald, and F. Medda, "The effect of heterogeneity on financial contagion due to overlapping portfolios," *LSE Research Online Documents on Economics*, vol. 19, no. 8, Article ID 1650016, 2017.
- [38] F. Allen, A. Babus, and E. Carletti, "Asset commonality, debt maturity and systemic risk," *Journal of Financial Economics*, vol. 104, no. 3, pp. 519–534, 2012.
- [39] S. Poledna, J. L. Molinaborboa, S. MartInezjaramillo, M. V. D. Leij, and S. Thurner, "The multi-layer network nature of systemic risk and its implications for the costs of financial crises," *Journal of Financial Stability*, vol. 20, pp. 70–81, 2015.
- [40] F. Caccioli, J. D. Farmer, N. Foti, and D. Rockmore, "Overlapping portfolios, contagion, and financial stability," *Journal of Economic Dynamics and Control*, vol. 51, pp. 50–63, 2015.
- [41] G. Cimini and M. Serri, "Entangling credit and funding shocks in interbank markets," *PLOS One*, vol. 11, no. 8, Article ID e0161642, 2016.
- [42] A. Roncoroni, S. Battiston, E. Farfan, L. O. Leonardo, and S. Martinez Jaramillo, *Climate Risk and Financial Stability in the Network of Banks and Investment Funds*, 2019.
- [43] R. Grilli, G. Tedeschi, and M. Gallegati, "Bank interlinkages and macroeconomic stability," *International Review of Economics & Finance*, vol. 34, pp. 72–88, 2014.
- [44] T. C. Silva, M. A. da Silva, and B. M. Tabak, "Systemic risk in financial systems: a feedback approach," *Journal of Economic Behavior & Organization*, vol. 144, pp. 97–120, 2017.
- [45] F. Franzoni, E. Nowak, and L. Phalippou, "Private equity performance and liquidity risk," *The Journal of Finance*, vol. 67, no. 6, pp. 2341–2373, 2012.
- [46] J. H. Cochrane, "The risk and return of venture capital," *Journal of Financial Economics*, vol. 75, no. 1, pp. 3–52, 2005.
- [47] P. Giot and A. Schwienbacher, "IPOs, trade sales and liquidations: modelling venture capital exits using survival analysis," *Journal of Banking and Finance*, vol. 31, no. 3, pp. 679–702, 2007.
- [48] P. A. Gompers, "Grandstanding in the venture capital industry," *Journal of Financial Economics*, vol. 42, no. 1, pp. 133–156, 1996.
- [49] P. A. Gompers and J. Lerner, "The venture capital cycle," *Social Science Electronic Publishing*, vol. 15, no. 2, pp. 145–168, 2009.
- [50] J. H. Block, D. J. Cumming, and S. Vismara, "International perspectives on venture capital and bank finance for entrepreneurial firms," *Economia e Politica Industriale*, vol. 44, no. 1, pp. 3–22, 2017.
- [51] R. R. Townsend, "Propagation of financial shocks: the case of venture capital," *Management Science*, vol. 61, no. 11, Article ID 27822802, 2015.
- [52] D. Acemoglu, A. E. Ozdaglar, and A. Tahbaz-Salehi, "Systemic risk and stability in financial networks," *Social Science Electronic Publishing*, vol. 105, no. 2, pp. 564–608, 2015.
- [53] L. C. G. Rogers and L. A. M. Veraart, "Failure and rescue in an interbank network," *Management Science*, vol. 59, no. 4, pp. 882–898, 2013.
- [54] M. Bardoscia, S. Battiston, F. Caccioli, and G. Caldarelli, "Debtrank: a microscopic foundation for shock propagation," *PLOS One*, vol. 10, no. 6, pp. 1887–1888, 2015.
- [55] P. Barucca, M. Bardoscia, F. Caccioli et al., *Network Valuation in Financial System*, 2016.
- [56] <https://zephyr.bvdinfo.com/>
- [57] M. Molloy and B. Reed, "A critical point for random graphs with a given degree sequence," *Random Structures & Algorithms*, vol. 6, no. 2–3, pp. 161–180, 1995.
- [58] M. Molloy and B. Reed, "The size of the giant component of a random graph with a given degree sequence," *Combinatorics, Probability and Computing*, vol. 7, no. 3, pp. 295–305, 1998.



**Hindawi**

Submit your manuscripts at  
[www.hindawi.com](http://www.hindawi.com)

