

Research Article

Optimal Control Analysis of Treatment Strategies of the Dynamics of Cholera

Sani Fakai Abubakar ¹ and M. O. Ibrahim ²

¹*Kebbi State University of Science and Technology, Aliero, Nigeria*

²*Department of Mathematics, University of Ilorin, Ilorin, Nigeria*

Correspondence should be addressed to Sani Fakai Abubakar; saniabufakai@hotmail.com

Received 25 January 2022; Revised 2 April 2022; Accepted 7 April 2022; Published 17 August 2022

Academic Editor: Ri-Dong Zhang

Copyright © 2022 Sani Fakai Abubakar and M. O. Ibrahim. This is an open access article distributed under the Creative Commons Attribution License, which permits unrestricted use, distribution, and reproduction in any medium, provided the original work is properly cited.

A nine-compartment deterministic cholera model was formulated, and the model describes interactions between human, *Vibrio cholerae* bacteria, and the environment that warrant the interaction. Realities and socioeconomic burden influence spread and control mechanism of the disease. The model investigated some effective ways of hindering cholera outbreak and spread. The existence and uniqueness of solution of the system of equations that the model comprises were ascertained. The basic reproduction number R_0 of the model was obtained using “next-generation matrix” method, and the most sensitive parameters were identified using “normalised forward sensitivity index” method. Three controls, hygiene consciousness denoted by X_1 , cholera vaccine X_2 , and cholera awareness programme X_3 , were chosen. Optimal control theory is applied to ascertain the level of effect of the controls in reducing susceptible, exposed, infected individuals and causative pathogen population. Pontryagin’s maximum principle is used to prove the optimal solution of the model, and the optimal system was derived and numerically solved. Simulations were made with graphs that show the effects of the controls on susceptible, exposed, infected, and *Vibrio cholerae* population. The findings are that simultaneous application of the three controls can be one of the fast and effective ways of controlling cholera. If two controls are to be selected, hygiene consciousness and vaccine are the best combination.

1. Introduction

Cholera is a profuse diarrhoeal disease that can lead to death within short period of onset, if prompt treatment measures are not taken. It was estimated in [1], to be annually causing 21,000 to 143,000 deaths from 1,300,000 to 4,000,000 cholera cases worldwide, representing 1.62% to 3.58% of the reported cases. Natural disasters, climate change, social conflicts (terrorism), and economic meltdown usually force people to live in slums and refugee camps. The camps usually have very poor or insufficient infrastructures, especially good drinking water, and this serves as igniting factors of cholera outbreaks [2].

Severe cholera symptoms include vomiting, profuse rice-water stool, cramps, sunken eyes, high dehydration, and

shock. Individuals that ingest incomplete cholera-causing dose do not usually manifest any cholera symptom and are usually referred as *Vibrio cholerae* carriers [3]. Severe cholera usually leads to death within short period of time that ranges between hours and three days. Chance of exposed susceptible individuals catching cholera will be half, if the concentration of *Vibrio cholerae* is 10^5 cells per millilitre (i.e., $B = k$) and the least daily consumption of untreated water per day is a minimum of 1 litre per day [4].

Pontryagin’s maximum principle is one of the few methods of obtaining analytical solutions to optimal control problems. [5] derived optimal control model SIB, with two controls, and [6] derived an optimal intervention strategies model. [7] presented and analysed optimal control model for cholera disease with three controls, and [8] derived $SEIRV_1V_E$ cholera model and

introduced an exposed individual compartment. They all used Pontryagin's maximum principle to analyse their models.

Big risk in cholera disease and its outbreaks is that about 75% of *Vibrio cholerae* carriers do not have symptoms of the disease, but can spread the bacteria in the community through their faeces for one to two weeks after infection [9]. Cholera infection can be asymptomatic, mild or moderate, and severe; among the infected individuals that manifest symptoms, only 20% develop severe watery diarrhoea, while 80% have mild or moderate symptoms [10].

This calls for the formulation of cholera model that will analyse dynamics of *Vibrio cholerae* carriers during and after cholera outbreak, to optimise application of hygiene, vaccination, and cholera awareness programme controls. The paper is organised as follows: Section 2 describes the model formulation, which comprises the basic assumptions, description of state variables and parameters, system of differential equations, existence and uniqueness of solution, positivity of solution, and disease-free and endemic equilibria. Section 3 discusses the calculation of basic reproduction number and sensitivity of its parameters. Section 4 defines optimal control. Section 5 illustrates numerical simulation, and Section 6 explains summary, conclusion, and recommendations.

2. Model Formulation

We derive a mathematical model of the dynamics of cholera disease, with homogeneous total number of humans denoted by P_H representing combined human population at time t . This human population of the model is divided into eight mutually exclusive compartments and one nonhuman compartment.

2.1. Basic Assumptions of the Model

- (i) Exposed individuals imply a very short period at which individuals have ingested *Vibrio cholerae* bacteria but yet to develop symptoms and cannot spread cholera pathogens
- (ii) Infected individuals cannot be vaccinated
- (iii) Infection can be as follows:
 - (a) Moderate cholera infection, individuals that have the pathogen in their system but did not develop into cholera disease
 - (b) Severe cholera infection, infected individuals that have manifested symptoms
- (iv) Moderate infected individuals can recover without treatment
- (v) Severe cholera infection must be treated before recovery
- (vi) Recovered individuals have no permanent cholera immunity

2.2. *State Variables and Parameters of the Model.* Description of the model's state variables and parameters is shown in Tables 1 and 2.

2.3. *The Model's Equations.* Schematic diagram of the flow between different classes of the state variables $S, V, E, I, C, U, T, R,$ and B of the model is shown in Figure 1.

A system of differential equations (1)–(9) was obtained from the model's assumptions, descriptions of variables and parameters, and the compartmental flow diagram.

$$\begin{aligned} \frac{dS}{dt} = & q - (v_1(1-\chi)\phi S + (1-\chi)(1-h)v_2SI) \\ & + \omega V + \omega R - (\psi + \delta)S, \end{aligned} \quad (1)$$

$$\frac{dV}{dt} = \psi S - \sigma v_2VI - (\omega + \delta)V, \quad (2)$$

$$\begin{aligned} \frac{dE}{dt} = & v_1(1-\chi)\phi S + (1-\chi)(1-h)v_2SI \\ & + \sigma v_2VI - (\xi + h + \delta)E, \end{aligned} \quad (3)$$

$$\frac{dI}{dt} = \xi E - (\tau m + (1-\tau)m + \epsilon + \delta)I, \quad (4)$$

$$\frac{dC}{dt} = hE - (f + \theta + \delta)C, \quad (5)$$

$$\frac{dU}{dt} = fC + (1-\tau)mI + g_2T - (g_1 + r_1 + \mu + \delta)U, \quad (6)$$

$$\frac{dT}{dt} = \tau mI + g_1U - (g_1 + r_2 + g_2 + \alpha + \delta)T, \quad (7)$$

$$\frac{dR}{dt} = (g_1 + r_2)T + r_1U + \theta C - (\omega + \delta)R, \quad (8)$$

$$\frac{dB}{dt} = (1-h)\eta_1I + (\eta_2 - \beta)B. \quad (9)$$

2.4. *Properties of the Model.* Properties that ensure the correctness of the system of equations of the model, such as existence, uniqueness, boundedness, positivity, and equilibria, are ascertained.

2.4.1. *Existence and Uniqueness of Solution.* The existence and uniqueness of solution in formulated mathematical models need to undergo surety test to ascertain whether the solution exists, and if it exists, it is unique. Using the Lipschitz criteria, it is established as follows.

Let

TABLE 1: State variables of the model.

Variable	Description
S	Susceptible individuals
V	The vaccinated individuals
E	Exposed individuals
I	Infected individuals
C	Hygiene conscious individuals
U	Untreated <i>Vibrio cholerae</i> carries
T	Infected individuals under treatment
R	Recovered individuals
B	Concentration of <i>Vibrio cholerae</i> bacteria in food and water consumed by the human population

TABLE 2: Description of parameters of the model, their values, units, and references (source).

Parameter	Symbol	Value	Unit	Source
Human recruitment rate	q	9.49	day^{-1}	Estimated
Non-cholera human death rate	δ	0.01177	day/1000	Calculated
Rate of ingesting <i>Vibrio cholerae</i> bacteria from contaminated food and water consumed by the human population	v_1	0.5	day^{-1}	[11]
Rate of getting <i>Vibrio cholerae</i> bacteria through human-to-human interactions	v_2	0.03	day^{-1}	[11]
Rate of recovery of hygiene conscious individuals	θ	0.38	day^{-1}	[11]
Hygiene consciousness of individuals	h	0.604	day^{-1}	Estimated
Rate of <i>Vibrio cholerae</i> decrease	η_2	0.033	day^{-1}	[12]
Rate at which infected individuals increase <i>Vibrio cholerae</i> bacteria in the environment	η_1	10	Cells/ml/day	[13]
Rate of generating <i>Vibrio cholerae</i> bacteria in the environment	β	0.073	day^{-1}	[7]
Rate of freedom from <i>Vibrio cholerae</i> by the hygiene conscious individuals	f	0.65	day^{-1}	Estimated
Concentration of cholera pathogen that yields 50% chance of individual developing cholera disease	k	10^5	Cells/ml	[14]
Progression of recovery of treated individuals to untreated <i>Vibrio cholerae</i> carriers	g_1	0.08	day^{-1}	Estimated
Rate of interruption of treatment	g_2	0.2	day^{-1}	[15]
Recovery rate of untreated <i>Vibrio cholerae</i> carriers	r_1	0.8	day^{-1}	Estimated
Recovery of treated cholera patients	r_2	0.63	day^{-1}	Estimated
Disease induced death rate for individuals in I class	ϵ	0.105	day^{-1}	Estimated
Disease induced death rate for individuals in U class	μ	0.1	day^{-1}	Estimated
Disease induced death rate for individuals in T class	α	0.08	day^{-1}	Estimated
Rate of movement of the infected class	m	0.24	day^{-1}	Estimated
Rate of vaccine	ψ	0.3	day^{-1}	[16]
Rate of waning out of the vaccine induced immunity	ω	0.5	day^{-1}	[16]
Rate at which the vaccine reduces infection	σ	0.2	day^{-1}	[16]
Cholera awareness programme	χ	0.66	day^{-1}	Estimated
Rate of exposure to infection	ξ	0.23	day^{-1}	Estimated
The fraction $B/(k + B)$	ϕ	0.000599	Dimensionless	Calculated
A fraction of early infected individuals	τ	0-1	Dimensionless	[15]

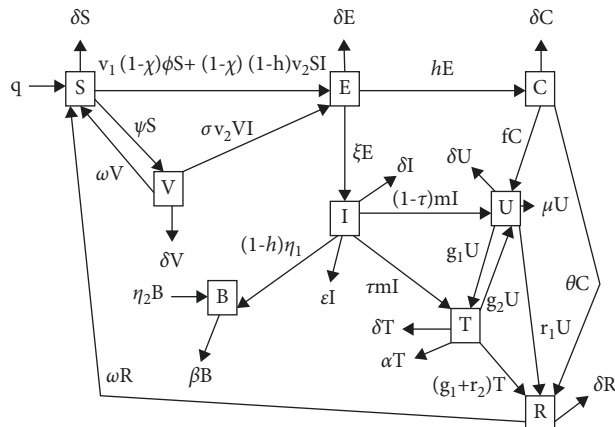

FIGURE 1: Flow diagram of the SVEICUTRB dynamic model.

$$\begin{aligned}
u_1 &= q - (v_1(1-\chi)\phi S + (1-\chi)(1-h)v_2SI) \\
&\quad + \omega V + \omega R - (\psi + \delta)S, \\
u_2 &= \psi S - \sigma v_2VI - (\omega + \delta)V, \\
u_3 &= v_1(1-\chi)\phi S + (1-\chi)(1-h)v_2SI + \sigma v_2VI \\
&\quad - (\xi + h + \delta)E, \\
u_4 &= \xi E - (m + \varepsilon + \delta)I, \\
u_5 &= hE - (f + \theta + \delta)C, \\
u_6 &= fC + (1-\tau)mI + g_2T - (g_1 + r_1 + \mu + \delta)U, \\
u_7 &= \tau mI + g_1U - (g_1 + r_2 + g_2 + \alpha + \delta)T, \\
u_8 &= (g_1 + r_2)T + r_1U + \theta C - (\omega + \delta)R, \\
u_9 &= (1-h)\eta_1I + (\eta_2 - \beta)B.
\end{aligned} \tag{10}$$

Considering the region $0 \leq P \leq \mathfrak{R}$, bounded solution of system of equations (1)–(9) will be looked for in the same region whose partial derivatives satisfy $\delta_1 \leq P \leq \mathfrak{R}$, where δ_1 and P are positive constants.

Theorem 1. *Let the region $0 \leq P \leq \mathfrak{R}$ be denoted by Λ , and then, the system of equations (1)–(9) has a unique solution provided that it is established that*

$$\frac{\partial u_i}{\partial t_j}, \quad i = 1, 2, 3, 4, 5, 6, 7, 8, 9, \tag{11}$$

is continuous and bounded in Λ .

Proof. Partial derivatives with respect to each state variables of the system of equations (1)–(9) are obtained as follows: for u_1 ,

$$\begin{aligned}
\left| \frac{\partial u_1}{\partial S} \right| &= |-v_1(1-\chi)\phi - (1-\chi)(1-h)v_2I - \psi - \delta| < \infty, \\
\left| \frac{\partial u_1}{\partial V} \right| &= |\omega| < \infty, \\
\left| \frac{\partial u_1}{\partial I} \right| &= |-(1-\chi)(1-h)v_2S| < \infty, \\
\left| \frac{\partial u_1}{\partial B} \right| &= \left| \frac{v_1(1-\chi)BS}{(k+B)^2} - \frac{v_1(1-\chi)S}{k+B} \right| < \infty, \\
\left| \frac{\partial u_1}{\partial R} \right| &= |\omega| < \infty, \\
\left| \frac{\partial u_1}{\partial E} \right| &= \left| \frac{\partial u_1}{\partial C} \right| = \left| \frac{\partial u_1}{\partial U} \right| = \left| \frac{\partial u_1}{\partial T} \right| = 0 < \infty.
\end{aligned} \tag{12}$$

Similarly, for $u_2, u_3, u_4, u_5, u_7, u_8$, and u_9 , the system of equations (1)–(9) exists and has a unique solution in \mathfrak{R}^9 since all the partial derivatives are $< \infty$ and therefore bounded and defined. \square

2.5. Positivity of Solutions. Let equations (1)–(9) be subject to initial conditions:

$$S(0), V(0), E(0), I(0), C(0), U(0), T(0), R(0), B(0). \tag{13}$$

For the SVEICUTRB cholera model to be meaningfully epidemiological, it is mandatory to prove that all the state variables are nonnegative at time $t > 0$, since the population of human is non negative but positive. This implies that the solutions of the system of equations (1)–(9) have nonnegative initial values and will remain nonnegative for all time $t > 0$.

Let

$$(S(t), V(t), E(t), I(t), C(t), U(t), T(t), R(t), B(t)), \tag{14}$$

be solutions to the system of the equations (1)–(9).

Theorem 2. (a) *Solution (11) is positive for all $t > 0$ if $S(0) > 0, V(0) > 0, E(0) > 0, I(0) > 0, C(0) > 0, U(0) > 0, T(0) > 0, R(0) > 0$, and $B(0) > 0$. (b) *Solution (11) is non-negative for all $t > 0$ with respect to initial conditions (10).**

Proof. (a) Suppose that (11) is defined for all $t \in [0, M)$, where $M > 0$, to prove that (11) is positive for all $t \geq 0$.

Considering (1), it is obvious that

$$\frac{dS(t)}{dt} \geq -(v_1(1-\chi)\phi + (1-\chi)(1-h)v_2I + \psi + \delta)S. \tag{15}$$

Integrating both sides of (15) with respect to p , with the range $p = 0$ to $p = t$, and applying initial condition, it gives

$$S(t) = S(0)\exp\left(\int_0^t -(v_1(1-\chi)\phi + (1-\chi)(1-h)v_2I + \psi + \delta)dp\right). \tag{16}$$

Since $S(0) > 0, \forall t \in [0, M)$.

Therefore,

$$S(0)\exp(-(v_1(1-\chi)\phi + (1-\chi)(1-h)v_2I + \psi + \delta)t), \tag{17}$$

must be greater than zero.

Also, from (2)

$$\frac{dV(t)}{dt} \geq -(\sigma v_2I + \omega + \delta)V, \forall 0 \leq t < M. \tag{18}$$

Integrating both sides within the interval $[0, t]$ and applying initial conditions, it gives

$$V(t) = V(0)\exp(-(\sigma v_2I + \omega + \delta)t), \tag{19}$$

and since $V(0) > 0, V(0)\exp(-(\sigma v_2I + \omega + \delta)t)$ must be greater than zero.

Similarly, from equations (3)–(9), their respective results are as follows:

$$\begin{aligned}
E(t) &\geq E(0)\exp(-(\xi + h + \delta)t) > 0, \quad \forall 0 \leq t < M, \\
I(t) &\geq I(0)\exp(-(\tau m + (1-\tau)m + \varepsilon + \delta)t) > 0, \quad \forall 0 \leq t < M, \\
C(t) &\geq C(0)\exp(-(\theta + \delta)t) > 0, \quad \forall 0 \leq t < M, \\
U(t) &\geq U(0)\exp(-(\mu + \delta)t) > 0, \quad \forall 0 \leq t < M, \\
T(t) &\geq T(0)\exp(-(\alpha + \delta)t) > 0, \quad \forall 0 \leq t < M, \\
R(t) &\geq R(0)\exp(-(\omega + \delta)t) > 0, \quad \forall 0 \leq t < M, \\
B(t) &\geq B(0)\exp(-\beta t) > 0, \quad \forall 0 \leq t < M.
\end{aligned} \tag{20}$$

(b) With the aid of proof of (a) and since the solution of the system of equations (1)–(9) continuously depends on the respective initial conditions in neighbourhood of zero, obviously it implies that (14) is nonnegative for all $0 \leq t < M$.

The model is dealing with population of living things, their number cannot be negative, and hence they are positive. \square

Theorem 3. *Solutions of cholera model SVEICUTRB are bounded in \mathfrak{R}_+^9 with initial conditions (10), and hence, dynamics of the model is a dynamical system in the biologically feasible compact set.*

Proof. Let $\Lambda = (S, V, E, I, C, U, T, R, B) \in \mathfrak{R}_+^9$ be the solutions of the model with nonnegative initial conditions. Total human population is as follows:

$$P_H = S + V + E + I + C + U + T + R,$$

$$\frac{dP_H}{dt} = \frac{dS}{dt} + \frac{dV}{dt} + \frac{dE}{dt} + \frac{dI}{dt} + \frac{dC}{dt} + \frac{dU}{dt} + \frac{dT}{dt} + \frac{dR}{dt},$$

$$\frac{dP_H}{dt} = q - \delta(S + V + E + I + C + U + T + R) - \epsilon I - \alpha T - \mu U. \quad (21)$$

Without cholera infection, all the cholera-related deaths will be zero; therefore, $\epsilon I = \alpha T = \mu U = 0$.

$$\frac{dP_H}{dt} = q - \delta P_H. \quad (22)$$

Using differential inequality theorem from [17] and the Birkhoff and Rota version as used in [11, 18],

$$\frac{dP_H}{dt} \leq q - \delta P_H. \quad (23)$$

Multiplying both sides of (23) by the integrating factor $\exp(\delta t)$ and integrating, it gives

$$P_H \exp(\delta t) \leq \frac{q}{\delta} + C. \quad (24)$$

Substituting initial conditions are as follows: $t = 0$ and $P_H(0) = P_0$.

This further gives $P_H \leq (q/\delta) + (P_0 - q/\delta)\exp(-\delta t)$

As $t \rightarrow \infty$, $(P_0 - (q/\delta))\exp(-\delta t) \rightarrow 0$, which gives $P_H \leq (q/\delta)$, but $P_H \geq 0$; therefore, for all $t > 0$,

$$0 \leq P_H(t) \leq \frac{q}{\delta}. \quad (25)$$

Hence, $P_H(t)$ is bounded.

The solution set of human population of the system of equations (1)–(9) belongs to the feasible region:

$$\Lambda_H = \left\{ (S, V, E, I, C, U, T, R) \in \mathfrak{R}_+^8, P_H \leq \frac{q}{\delta} \right\}. \quad (26)$$

Also, let

$$P_H(t) \leq P_H^* = \max \left\{ P_0, \frac{q}{\delta} \right\}. \quad (27)$$

On the other hand, the equation for the dynamics of the pathogen is (9) as follows:

$$\begin{aligned} \frac{dB(t)}{dt} &= (1-h)\eta_1 I + (\eta_2 - \beta)B(t) \\ &\leq (\eta_2 - \beta)B(t) + (1-h)\eta_1 P_H. \end{aligned} \quad (28)$$

Since I can be less than (q/δ) , then from (27),

$$\frac{dP_B(t)}{dt} \leq (\eta_2 - \beta)B(t) + (1-h)\eta_1 P_H^*. \quad (29)$$

Integrating (29) gives

$$P_B(t) \leq \frac{(1-h)\eta_1 P_H^*}{(\eta_2 - \beta)B(t)} [1 - \exp(-(\eta_2 - \beta)t)] + \frac{B(0)}{\exp((\eta_2 - \beta)t)}. \quad (30)$$

As $t \rightarrow \infty$, then $\exp((\eta_2 - \beta)t) \rightarrow 0$.

The population of *Vibrio cholerae* bacteria is as follows:

$$P_B(t) \leq \frac{(1-h)\eta_1 P_H^*}{(\eta_2 - \beta)}, \quad (31)$$

provided $\eta_2 \neq \beta$. Hence, the feasible solution set of *Vibrio cholerae* population of (9) enters the region

$$\Lambda_B = \left\{ P_B(t) \in \mathfrak{R}_+, 0 \leq P_B(t) \leq \frac{(1-h)\eta_1 P_H^*}{(\eta_2 - \beta)} \right\}. \quad (32)$$

This shows that the cholera model governed by the system of equations (1)–(9) is epidemiological well posed in a feasible region Λ , defined by $\Lambda \in \mathfrak{R}_+^9$ and $\Lambda_H \cup \Lambda_B \subset \mathfrak{R}_+^8 * \mathfrak{R}_+$.

It then implies that the entire human and nonhuman population of the model enter the feasible region Λ . Also, since $P_H(t) > 0$ and $P_B(t) \geq 0$, for all $t \geq 0$, then $P_H(t)$ and $P_B(t)$ cannot blow up to infinity in the finite time. Consequently, the model system is dissipative; that is, its solutions are bounded and exist for all $t > 0$ in the invariant and compact set Λ .

$$\Lambda = \left\{ S, V, E, I, C, U, T, R \in \mathfrak{R}_+^8, B \in \mathfrak{R}_+, S, V, E, I, C, U, T, R, B \geq 0, P_H \leq \frac{q}{\delta}, P_H \leq P_H^*, P_B \leq \frac{(1-h)\eta_1 P_H^*}{(\eta_2 - \beta)} \right\}. \quad (33)$$

The region Λ is positively invariant and attracts all solutions in \mathfrak{R}_+^9 . \square

2.5.1. Disease-Free Equilibrium. Analysis of cholera model governed by a system of equations (1)–(9) is qualitatively carried out to obtain features of the dynamics and impact of

control strategies, spread, and transmission dynamics of the cholera causative bacteria.

Disease-free equilibrium of the model governed by system of equations (1)–(9) is algebraically calculated by setting $(dS/dt) = (dV/dt) = (dE/dt) = (dI/dt) = (dC/dt) = (dU/dt) = (dT/dt) = (dR/dt) = (dB/dt) = 0$.

In the absence of cholera disease, it is assumed that $S = S_0, V = V_0, E = 0, I = 0, C = 0, U = 0, T = 0, R = 0$, and $B = 0$.

$$\begin{aligned} S_0 &= \frac{q(\omega + \delta)}{(\psi + \delta)(\omega + \delta) - \omega\psi}, \\ V_0 &= \frac{q\psi}{(\psi + \delta)(\omega + \delta) - \omega\psi}. \end{aligned} \quad (34)$$

The DFE point is as follows:

$$Q_0 = (S_0, V_0, E, I, C, U, T, R, B)$$

$$= \left(\frac{q(\omega + \delta)}{(\psi + \delta)(\omega + \delta) - \omega\psi}, \frac{q\psi}{(\psi + \delta)(\omega + \delta) - \omega\psi}, 0, 0, 0, 0, 0, 0, 0 \right). \quad (35)$$

2.5.2. Existence of Endemic Equilibrium State (EES) Ξ^* .

This is a state where the disease cannot be completely eliminated, but stay in the concern region. The state variables of the model with exception of R^* are not zero.

Let $\Xi^* = (S^*, V^*, E^*, I^*, C^*, U^*, T^*, R^*, B^*)$ be the endemic equilibrium point, and let

$$\begin{aligned} Q_1 &= \xi + h + \delta, \\ Q_2 &= m + \varepsilon + \delta, \\ Q_3 &= g_1 + r_1 + \mu + \delta, \\ Q_4 &= g_1 + g_2 + r_2 + \alpha + \delta, \\ Q_5 &= \psi + \delta, \\ Q_6 &= 1 - \chi, \\ Q_7 &= 1 - h, \\ Q_8 &= \frac{B}{k + B}, \\ Q_9 &= \omega + \delta, \\ Q_{10} &= f + \theta + \delta, \\ Q_{11} &= g_1 + r_2, \\ Q_{12} &= \eta_2 - \beta. \end{aligned} \quad (36)$$

Substituting (37) into the system of equations (1)–(9), the following is obtained:

$$q - \nu_1 Q_6 Q_8 S^* - Q_6 Q_7 \nu_2 S^* I^* + \omega V^* + \omega R^* - Q_5 S^* = 0, \quad (37)$$

$$\psi S^* - \sigma \nu_2 V^* I^* - Q_9 V^* = 0, \quad (38)$$

$$\nu_1 Q_6 Q_8 S^* + Q_6 Q_7 \nu_2 S^* I^* + \sigma \nu_2 V^* I^* - Q_1 E^* = 0, \quad (39)$$

$$\xi E^* - Q_2 I^* = 0, \quad (40)$$

$$h E^* - Q_{10} C^* = 0, \quad (41)$$

$$f C^* + (1 - \tau) m I^* + g_2 T^* - Q_3 U^* = 0, \quad (42)$$

$$\tau m I^* + g_1 U^* - Q_4 T^* = 0, \quad (43)$$

$$Q_{11} T^* + r_1 U^* + \theta C^* - Q_9 R^* = 0, \quad (44)$$

$$Q_7 \eta_1 I^* + Q_{12} B^* = 0, \quad (45)$$

Adding (19) and (21),

$$q + \omega R^* + (\omega + \delta \nu_2 I^*) V^* - Q_5 S^* - Q_1 E^* = 0. \quad (46)$$

From (22),

$$E^* = \frac{Q_2 I^*}{\xi}, \quad (47)$$

and from (23),

$$C^* = \frac{h E^*}{Q_{10}}. \quad (48)$$

Putting (40) into (41),

$$C^* = \frac{h Q_2 I^*}{\xi Q_{10}}. \quad (49)$$

From (25),

$$T^* = \frac{\tau m I^* + g_1 U^*}{Q_4}. \quad (50)$$

Substituting (42) and (43) into (24) gives

$$U^* = \frac{f h Q_2 Q_4 I^* + \xi Q_4 Q_{10} (1 - \tau) m I^* + \xi Q_{10} g_2 \tau m I^*}{\xi Q_{10} (Q_3 Q_4 - g_1)}. \quad (51)$$

Let

$$\begin{aligned}
H_1 &= fhQ_2Q_4, \\
H_2 &= \xi Q_4Q_{10}(1-\tau)m, \\
H_3 &= \xi Q_{10}g_2\tau m, \\
H_4 &= \xi Q_{10}(Q_3Q_4 - g_1), \\
H_5 &= Q_{10}Q_{11}\xi(\tau mH_4 + g_1(H_1 + H_2 + H_3)), \\
H_6 &= \xi r_1Q_4Q_{10}(H_1 + H_2 + H_3), \\
H_7 &= \theta hQ_2Q_4H_4, \\
H_8 &= \xi H_4Q_4Q_9Q_{10}.
\end{aligned} \tag{52}$$

Substituting related terms of (45) into (44) gives

$$U^* = \left(\frac{H_1 + H_2 + H_3}{H_4} \right) I^*, \tag{53}$$

and from (43),

$$T^* = \left(\frac{\tau mH_4 + g_1(H_1 + H_2 + H_3)}{H_4Q_4} \right) I^*. \tag{54}$$

From (20),

$$V^* = \frac{\psi S^*}{\sigma v_2 I^* - Q_9}. \tag{55}$$

Putting (31), (35), and (36) in (26), we obtain

$$R^* = \frac{(H_5 + H_6 + H_7)I^*}{H_8}. \tag{56}$$

Also let

$$\left. \begin{aligned}
H_{10} &= H_8\xi q + \xi\omega(H_5 + H_6 + H_7) - H_8Q_1Q_2, \\
H_{11} &= \sigma v_2(Q_5 - \psi), \\
H_{12} &= Q_5Q_9 - \psi\omega.
\end{aligned} \right\} \tag{57}$$

Substituting (29), (37), (38), and related terms of (50) in (39) gives

$$S^* = \frac{H_{10}I^*(\sigma v_2 I^* - Q_9)}{H_{11}I^* - H_{12}}. \tag{58}$$

Substituting (51) into (48) and simplifying, (48) becomes

$$V^* = \frac{\psi H_{10}I^*}{H_{11} - H_{12}}. \tag{59}$$

Substituting (29), (40), and (41) into (21) gives the following:

$$\left. \begin{aligned}
&\xi v_2^2 Q_6 Q_7 H_{10} \sigma I^{*3} \\
&+ (\xi H_{10} \sigma v_1 v_2 Q_6 Q_8 - \xi H_{10} v_2 Q_6 Q_7 Q_9 + \xi \psi H_{10} \sigma v_2 - Q_1 Q_2 H_{11}) I^{*2} \\
&+ (H_{12} Q_1 Q_2 - \xi H_{10} v_1 Q_6 Q_8 Q_9) I^* = 0
\end{aligned} \right\} \tag{60}$$

setting

$$\left. \begin{aligned}
B_1 &= \xi v_2^2 Q_6 Q_7 H_{10} \sigma, \\
B_2 &= \xi H_{10} \sigma v_1 v_2 Q_6 Q_8 - \xi H_{10} v_2 Q_6 Q_7 Q_9 + \xi \psi H_{10} \sigma v_2 - Q_1 Q_2 H_{11}, \\
B_3 &= H_{12} Q_1 Q_2 - \xi H_{10} v_1 Q_6 Q_8 Q_9.
\end{aligned} \right\} \tag{61}$$

This gives

$$\begin{aligned}
B_1 I^{*3} + B_2 I^{*2} + B_3 I^* &= 0, \\
(B_1 I^{*2} + B_2 I^* + B_3) I^* &= 0,
\end{aligned} \tag{62}$$

which means either

$$B_1 I^{*2} + B_2 I^* + B_3 = 0, \tag{63}$$

or

$$I^* = 0. \tag{64}$$

For $I^* = 0$, it implies a disease-free equilibrium; when $H_{12}Q_1Q_2 < \xi H_{10}v_1Q_6Q_8Q_9$, it implies $B_1 > 0$ and $B_3 < 0$; hence, product of the roots $I_1^*I_2^* = (B_3/B_1) < 0$, which means either $I_1^* > 0$ or $I_2^* > 0$, and the positive root will then be

$$I^* = \frac{-B_2 + \sqrt{B_2^2 - 4B_1B_3}}{2B_1}. \tag{65}$$

Therefore, there exists an endemic equilibrium state Ξ^* defined as follows:

$$\begin{aligned}
\Xi^* &= \left(\frac{H_{10}\sigma v_2 \Delta^2 - H_{10}Q_9\Delta}{H_{11}\Delta - H_{12}}, \frac{\psi H_{10}\Delta}{H_{11}\Delta - H_{12}}, \frac{Q_2\Delta}{\xi}, \Delta, \frac{hQ_2\Delta}{\xi Q_{10}}, \right. \\
&\quad \cdot \frac{(H_1 + H_2 + H_3)\Delta}{H_4}, \frac{(\tau mH_4 + g_1(H_1 + H_2 + H_3))\Delta}{H_4Q_4}, \\
&\quad \left. \cdot \frac{(H_5 + H_6 + H_7)\Delta}{H_8} \right),
\end{aligned} \tag{66}$$

where

$$\Delta = \frac{-B_2 + \sqrt{B_2^2 - 4B_1B_3}}{2B_1}. \tag{67}$$

Note that $\eta_2 - \beta$ must be negative for endemic.

3. Basic Reproduction Number R_0

Basic reproduction number denoted by R_0 is the average number of secondary infections produced by a single infective introduced into the whole susceptible population.

R_0 is a threshold quantity that can be used to predict infection; when $R_0 < 1$, it implies that only less than one person can be infected, which means the disease dies out.

When $R_0 > 1$ implies that more than one person can be infected, this means the disease will persist.

There are many methods of obtaining R_0 for mathematical models, and “the next-generation matrix method,” a technique introduced by [19], which was also reported by [20], was used in this work, simply because the model is divided into compartments.

Taking F_i to be the rate of appearance of new infection in compartment i , V_i is the transfer of individuals out of compartment i by other means and substituting values of state variables at disease-free equilibrium point Q_0 . R_0 will then be the spectral radius of

$$\left[\frac{\partial F_i(Q_0)}{\partial Q_j} \right] \cdot \left[\frac{\partial V_i(Q_0)}{\partial Q_j} \right]^{-1}. \quad (68)$$

Note that F is nonnegative, V is a nonsingular M matrix, V^{-1} is nonnegative, and FV^{-1} is also nonnegative as in [19]. The matrix FV^{-1} was referred as the next-generation matrix as in [20] that gave the method its name. Finally, $R_0 = \rho(FV^{-1})$, which is the spectral radius of FV^{-1} , considered as maximum real part of the matrix FV^{-1} . Rearranging the equations of the model as $F(t)$, $V_+(t)$, and $V_-(t)$, the R_0 is calculated and obtained as follows:

$$F(t) = \begin{bmatrix} v_1(1-\chi)\frac{B}{k+B}S + (1-\chi)(1-h)v_2SI + \sigma v_2VI \\ 0 \\ 0 \\ 0 \\ 0 \\ 0 \end{bmatrix},$$

$$V^+(t) = \begin{bmatrix} \xi E \\ fC + (1-\tau)mI + g_2T \\ \tau mI + g_1U \\ 0 \\ q + \omega V + \omega R \\ (1-h)\eta_1I + \eta_2B \end{bmatrix}, \quad (69)$$

$$V^-(t) = \begin{bmatrix} (\tau m + (1-\tau)m + \varepsilon + \delta)I \\ (g_1 + r_1 + \mu + \delta)U \\ (g_1 + g_2 + r_2 + \alpha + \delta)T \\ (\xi + h + \delta)E \\ v_1(1-\chi)\frac{B}{k+B}S + (1-\chi)(1-h)v_2SI + (\psi + \delta)S \\ \beta B \end{bmatrix},$$

with $V(t) = V^-(t) - V^+(t)$.

$$V(t) = \begin{bmatrix} (\tau m + (1 - \tau)m + \varepsilon + \delta)I - \xi E \\ (g_1 + r_1 + \mu + \delta)U - fC - (1 - \tau)mI - g_2T \\ (g_1 + g_2 + r_2 + \alpha + \delta)T - \tau mI - g_1U \\ (\xi + h + \delta)E \\ v_1(1 - \chi)\frac{B}{k+B}S + (1 - \chi)(1 - h)v_2SI + (\psi + \delta)S - q - \omega V - \omega R \\ \beta B - (1 - h)\eta_1I - \eta_2B \end{bmatrix}. \quad (70)$$

Substituting terms given by (37), it gives

$$F(t) = \begin{bmatrix} v_1Q_6Q_8S + Q_6Q_7v_2SI + \sigma v_2VI \\ 0 \\ 0 \\ 0 \\ 0 \\ 0 \end{bmatrix}, \quad (71)$$

$$V1(t) = \begin{bmatrix} Q_2I - \xi E \\ Q_3U - fC - (1 - \tau)mI - g_2T \\ Q_4T - \tau mI - g_1U \\ Q_1E \\ v_1Q_6Q_8S + Q_6Q_7v_2SI + Q_5S - q - \omega V - \omega R \\ \beta B - Q_7\eta_1I - \eta_2B \end{bmatrix}.$$

$$V1_J = \begin{bmatrix} Q_2 & 0 & 0 & -\xi & 0 & 0 \\ -(1 - \tau)m & Q_3 & -g_2 & 0 & 0 & 0 \\ -\tau m & -g_1 & Q_4 & 0 & 0 & 0 \\ 0 & 0 & 0 & Q_1 & 0 & 0 \\ Q_6Q_7v_2S & 0 & 0 & 0 & Q_5 & \frac{Q_6v_1S}{k} \\ -Q_7\eta_1 & 0 & 0 & 0 & 0 & \beta - \eta_2 \end{bmatrix}. \quad (72)$$

Let $F^{-1} = F_J^{-1}$ and $V1^{-1} = V1_J^{-1}$.

The Jacobian matrices of $F(t)$ and $V1(t)$ about the disease-free equilibrium point Q_0 are obtained by partially differentiating $F(t)$ and $V1(t)$ with respect to I, U, T, E, S , and B to get matrices F_J and $V1_J$.

$$F_J = \begin{bmatrix} Q_6Q_7v_2S + \sigma v_2V & 0 & 0 & 0 & 0 & \frac{Q_6v_1S}{k} \\ 0 & 0 & 0 & 0 & 0 & 0 \\ 0 & 0 & 0 & 0 & 0 & 0 \\ 0 & 0 & 0 & 0 & 0 & 0 \\ 0 & 0 & 0 & 0 & 0 & 0 \\ 0 & 0 & 0 & 0 & 0 & 0 \end{bmatrix},$$

$$V_1^{-1} = \begin{bmatrix} \frac{1}{Q_2} & 0 & 0 & \frac{\xi}{Q_1 Q_2} & 0 & 0 \\ \frac{m(Q_4 \tau - g_2 \tau - Q_4)}{Q_2(Q_3 Q_4 - g_1 g_2)} & \frac{Q_4}{Q_3 Q_4 - g_1 g_2} & \frac{g_2}{Q_3 Q_4 - g_1 g_2} & \frac{m \xi (Q_4 \tau - g_2 \tau - Q_4)}{Q_2 Q_1 (Q_3 Q_4 - g_1 g_2)} & 0 & 0 \\ \frac{m(Q_3 \tau - g_1 \tau + g_1)}{Q_2(Q_3 Q_4 - g_1 g_2)} & \frac{g_1}{Q_3 Q_4 - g_1 g_2} & \frac{Q_3}{Q_3 Q_4 - g_1 g_2} & \frac{m \xi (Q_3 \tau - g_1 \tau + g_1)}{Q_2 Q_1 (Q_3 Q_4 - g_1 g_2)} & 0 & 0 \\ 0 & 0 & 0 & \frac{1}{Q_1} & 0 & 0 \\ \frac{Q_6 Q_7 S (\beta k v_2 - \eta_2 k v_2 + \eta_1 v_1)}{k Q_2 (\beta - \eta_2) Q_5} & 0 & 0 & \frac{Q_6 Q_7 \xi S (\beta k v_2 - \eta_2 k v_2 + \eta_1 v_1)}{k Q_2 Q_1 (\beta - \eta_2) Q_5} & \frac{1}{Q_5} & \frac{-Q_6 v_1 S}{k (\beta - \eta_2) Q_5} \\ \frac{Q_7 \eta_1}{Q_2 (\beta - \eta_2)} & 0 & 0 & \frac{Q_7 \eta_1 \xi}{Q_2 Q_1 (\beta - \eta_2)} & 0 & \frac{1}{\beta - \eta_2} \end{bmatrix}. \quad (73)$$

Let $Z = FV_1^{-1}$ and $R_0 = \rho(Z)$; hence, $R_0 = (qQ_6Q_7Q_9 \beta k v_2 - Q_6Q_7Q_9 \eta_2 k v_2 + Q_6Q_7Q_9 \eta_1 v_1 + \beta k \psi \sigma v_2 - \eta_2 k \psi \sigma v_2) / (Q_5 Q_9 - \omega \psi) k Q_2 (\beta - \eta_2)$.

$$R_0 = \frac{q((1-\chi)(1-h)(\omega+\delta)\beta k v_2 - (1-\chi)(1-h)(\omega+\delta)\eta_2 k v_2 + (1-\chi)(1-h)(\omega+\delta)\eta_1 v_1 + \beta k \psi \sigma v_2 - \eta_2 k \psi \sigma v_2)}{((\psi+\delta)(\omega+\delta) - \omega \psi) k (m + \varepsilon + \delta) (\beta - \eta_2)}. \quad (74)$$

3.1. Sensitivity Analysis. Sensitivity analysis is determining the level of effectiveness of parameters. The sensitivity analysis was carried out on model's R_0 . The most sensitive parameters in this model are h and v_2 ; increasing h reduces R_0 , thereby reducing infection. On the other hand, increasing v_2 increases R_0 , thereby increasing infection. The normalised forward sensitivity indexes were performed using the following formula:

$$\zeta_{\Omega}^{R_0} = \frac{\Omega}{R_0} \cdot \frac{\partial R_0}{\partial \Omega}, \quad (75)$$

where $\Omega = \{q, h, \delta, m, \varepsilon, v_1, v_2, \chi, \omega, \psi, \sigma, \beta, \eta_1, \eta_2, k\}$.

Using (68), the level of sensitivity of the R_0 parameters was obtained as given in Table 3. Level of sensitivity of each parameter in the obtained R_0 is shown in Figure 2.

4. Optimal Control Problem of the Model

Minimising susceptible, exposed, and infected individuals through hygiene consciousness, vaccine coverage, and cholera awareness strategies is the goal set to achieve using optimisation. The objectives of optimizing the model are: to reduce as much as possible, cholera susceptible individuals, exposed individuals, and cholera infection through three controls, hygiene consciousness of human, vaccinating

TABLE 3: Level of sensitivity of R_0 parameters.

Parameter	Sensitivity value	Parameter	Sensitivity value
q	1.0000	ω	-0.0512
h	-0.8671	ψ	0.0524
δ	-1.0390	σ	0.4219
m	-0.6415	β	-0.0026
ϵ	-0.3208	η_1	0.0023
v_1	0.0023	η_2	0.0004
v_2	0.9978	k	-0.0023
χ	-0.8671		

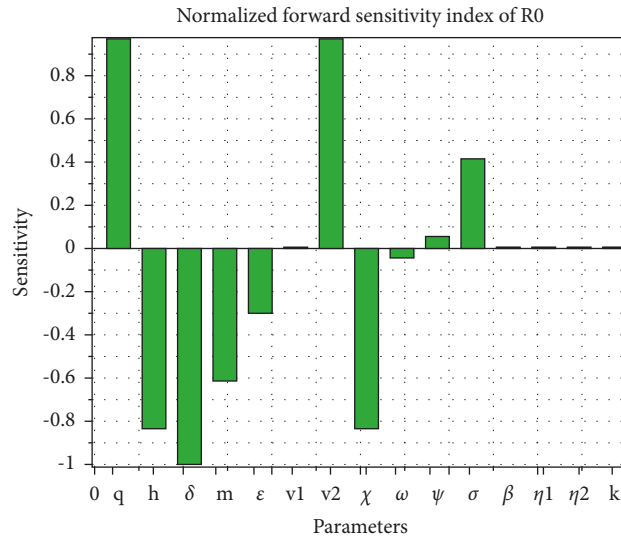

FIGURE 2: Graph of sensitivity analysis of parameters in the model’s “Basic reproduction number” R_0 .

susceptible individuals and awareness of measures to be taken to avoid cholera infection. The model is reformulated to identify permissible time-dependent controls $\chi_1(t)$, $\chi_2(t)$,

and $\chi_3(t)$, which are now functions of time t , and are, respectively, replacing parameters h , ψ , and χ of the system of equations (1)–(9) that is reformulated as follows:

$$\begin{aligned}
\frac{dS}{dt} &= q - \left(v_1(1 - \chi_3(t)) \frac{B(t)}{k + B(t)} S(t) + (1 - \chi_1(t))(1 - \chi_3(t)) v_2 S(t) I(t) \right) + \omega V(t) + \omega R(t) - (\chi_2(t) + \delta) S(t), \\
\frac{dV}{dt} &= \chi_2(t) S(t) - \sigma v_2 V(t) I(t) - (\omega + \delta) V(t), \\
\frac{dE}{dt} &= v_1(1 - \chi_3(t)) \frac{B(t)}{k + B(t)} S(t) + (1 - \chi_1(t))(1 - \chi_3(t)) v_2 S(t) I(t) + \sigma v_2 V(t) I(t) - (\xi + \chi_1(t) + \delta) E(t), \\
\frac{dI}{dt} &= \xi E(t) - (m + \epsilon + \delta) I(t), \\
\frac{dC}{dt} &= \chi_1(t) E(t) - (f + \theta + \delta) C(t), \\
\frac{dU}{dt} &= f C(t) + (1 - \tau) m I(t) + g_2 T(t) - (g_1 + r_1 + \mu + \delta) U(t), \\
\frac{dT}{dt} &= \tau m I(t) + g_1 U(t) - (g_1 + r_2 + g_2 + \alpha + \delta) T(t), \\
\frac{dR}{dt} &= (g_1 + r_2) T(t) + r_1 U(t) + \theta C(t) - (\omega + \delta) R(t), \\
\frac{dB}{dt} &= (1 - \chi_1(t)) \eta_1 I(t) + (\eta_2 - \beta) B(t).
\end{aligned} \tag{76}$$

Considering biological reasons, initial conditions of the state variables are assumed to be as follows: let $S(0) = S_0$ similarly for the remaining state variables $I_0 \geq 0, S_0 > 0, V_0 \geq 0, E_0 \geq 0, C_0 \geq 0, U_0 \geq 0, T_0 \geq 0, R_0 \geq 0$, and $B_0 \geq 0$.

Let the terminal time be T_f .

The objective functional or performance index of the model is as follows:

$$\begin{aligned}
J(\chi_1, \chi_2, \chi_3) &= \int_0^{T_f} (M_1 S(t) + M_2 E(t) + M_3 I(t) \\
&\quad + \frac{1}{2} (N_1 \chi_1^2 + N_2 \chi_2^2 + N_3 \chi_3^2)) dt.
\end{aligned} \tag{77}$$

The set of controls $w = \{\chi_1(t), \chi_2(t), \chi_3(t)\} \in L$ is Lebesgue measurable where

$$L = \{(\chi_1, \chi_2, \chi_3) | \chi_1, \chi_2, \chi_3: [0, T_f] \longrightarrow [0, 1], \forall \chi_1, \chi_2, \chi_3\}. \tag{78}$$

M_1, M_2 , and M_3 , respectively, denote the weight constant of susceptible, exposed, and infected, while N_1, N_2 , and N_3 , respectively, denote the constant relative cost weight of hygiene consciousness, rate of vaccine, and public awareness programme on cholera. The controls take their values in a closed interval $[0, 1]$.

$\chi_1 = 1$ implies inhibition of cholera outbreak and spread, while $\chi_1 = 0$ means no cholera outbreak and spread inhibition. $\chi_2 = 1$ implies 100% vaccination

coverage and effective cholera immune population. From general experience in vaccinations, as in [21], about 90% of susceptible is usually the maximum to be covered in vaccination programme. $\chi_2 = 0$ means the susceptible have only natural cholera immunity (which might be weak) and are not complimented with vaccine, and this in turn increases chance of catching cholera. $\chi_3 = 1$ implies full cholera awareness in the population, which is assumed to alert the community to observe preventive measures to contain and curtail cholera outbreak and spread. $\chi_3 = 0$ will render the population unaware of the best ways to avoid and prevent the disease outbreak and spread.

The main aim is to minimise susceptible, exposed, and infected individuals to a level that will reduce cholera disease escalation through these three controls, $(\chi_1^*, \chi_2^*, \chi_3^*)$ such that

$$J(\chi_1^*, \chi_2^*, \chi_3^*) = \min_{\chi_1, \chi_2, \chi_3} \{J(\chi_1, \chi_2, \chi_3) | \chi_1, \chi_2, \chi_3 \in L\}. \tag{79}$$

4.1. Existence of an Optimal Control Set. From (33), all feasible solutions of system (69) enter into the region Λ . The system (69) can be written in the form

$$\frac{dp}{dt} = Qp + Z(p), \tag{80}$$

where

$$p(t) = (S(t), V(t), E(t), I(t), C(t), U(t), T(t), R(t), B(t))^T. \quad (81)$$

$$Q = \begin{bmatrix} -B_1 & 0 & 0 & 0 & 0 & 0 & 0 & 0 & 0 \\ 0 & -B_2 & 0 & 0 & 0 & 0 & 0 & 0 & 0 \\ 0 & 0 & -B_3 & 0 & 0 & 0 & 0 & 0 & 0 \\ 0 & 0 & 0 & -B_4 & 0 & 0 & 0 & 0 & 0 \\ 0 & 0 & 0 & 0 & -B_5 & 0 & 0 & 0 & 0 \\ 0 & 0 & 0 & 0 & 0 & -B_6 & 0 & 0 & 0 \\ 0 & 0 & 0 & 0 & 0 & 0 & -B_7 & 0 & 0 \\ 0 & 0 & 0 & 0 & 0 & 0 & 0 & -B_8 & 0 \\ 0 & 0 & 0 & 0 & 0 & 0 & 0 & 0 & -B_8 \end{bmatrix},$$

$$Z(p) = \begin{bmatrix} q - B_9 S(t) - B_{10} S(t) + \omega V(t) + \omega R(t) \\ \chi_2(t) S(t) - B_{11} \\ B_9 S(t) + B_{10} S(t) + B_{11} \\ \xi E(t) \\ \chi_1(t) E(t) \\ fC(t) + (1 - \tau)mI(t) + g_2 T(t) \\ \tau mI(t) + g_1 U(t) \\ (g_1 + r_2)T(t) + r_1 U(t) + \theta C(t) \\ (1 - \chi_1(t))\eta_1 I(t) \end{bmatrix}, \quad (82)$$

where

$$\begin{aligned} B_1 &= \chi_1(t) + \delta, \\ B_2 &= \omega + \delta, \\ B_3 &= \xi + \chi_1(t) + \delta, \\ B_4 &= m + \varepsilon + \delta, \\ B_5 &= f + \theta + \delta, \\ B_6 &= g_1 + r_1 + \mu + \delta, \\ B_7 &= g_1 + r_2 + g_2 + \alpha + \delta, \\ B_8 &= \eta_2 + \beta, \\ B_9 &= v_1(1 - \chi_3(t)) \frac{B(t)}{k + B(t)}, \\ B_{10} &= (1 - \chi_1(t))(1 - \chi_3(t))v_2 I(t), \\ B_{11} &= \sigma v_2 V(t) I(t). \end{aligned} \quad (83)$$

$Z(p)$ satisfies

$$\begin{aligned} |Z(p_1) - Z(p_2)| &\leq \rho_1(|S_1(t) - S_2(t)|) + \rho_2(|V_1(t) - V_2(t)|) + \rho_3(|E_1(t) - E_2(t)|) \\ &\quad + \rho_4(|I_1(t) - I_2(t)|) + \rho_5(|C_1(t) - C_2(t)|) + \rho_6(|U_1(t) - U_2(t)|) \\ &\quad + \rho_7(|T_1(t) - T_2(t)|) + \rho_8(|R_1(t) - R_2(t)|) + \rho_9(|B_1(t) - B_2(t)|) \\ &\leq \rho_n(|S_1(t) - S_2(t)|) + (|V_1(t) - V_2(t)|) + (|E_1(t) - E_2(t)|) \\ &\quad + (|I_1(t) - I_2(t)|) + (|C_1(t) - C_2(t)|) + (|U_1(t) - U_2(t)|) \\ &\quad + (|T_1(t) - T_2(t)|) + (|R_1(t) - R_2(t)|) + (|B_1(t) - B_2(t)|), \end{aligned} \quad (84)$$

with the positive constant $\rho_n = \max(\rho_i \text{ for } i = 1, 2, \dots, 9)$, independent to the state variables $S(t)$, $V(t)$, $E(t)$, $I(t)$, $C(t)$, $U(t)$, $T(t)$, $R(t)$, and $B(t)$.

It follows that optimality system and the optimal controls exist and the solution of system is bounded, since

$$|Z(p_1) - Z(p_2)| \leq \rho_n |Z_1 - Z_2|, \quad (85)$$

where

$$\rho_n = \sum_{i=1}^9 \rho_i + |K| < \infty. \quad (86)$$

This follows that the function Z is uniformly Lipschitz continuous. Hence, the control variables and nonnegative initial conditions reveal that a solution of the system (69) exists (see [22, 23]).

Theorem 4. Given the objective functional (48) with set L defined in (49) subject to the system (46) with initial conditions (47), then there exists an optimal control set $w_1 = \{\chi_1^*, \chi_2^*, \chi_3^*\}$ such that (50) is true if the following conditions hold ($K(S, E, I, \chi_1, \chi_2, \chi_3) \leq \mu_2 - \mu_1(|\chi_1(t)|^2 + |\chi_2(t)|^2 + |\chi_3(t)|^2)^{\alpha/2}$):

- (i) The set of controls and corresponding state variables is nonempty
- (ii) The control set L is closed and convex
- (iii) Each right-hand side of (46) is continuous bounded above by a sum of the bounded control and state and can be written as a linear function w with coefficients depending on time and state
- (iv) The integrand of the objective functional is convex on L

(v) There exist nonnegative constants μ_1 and μ_2 and $\alpha_1 > 1$ satisfying the following expression

Proof. Using established approach as in [6, 24, 25], the existence of solution of (46) is satisfied, the bounded

coefficients and all solutions are bounded on a finite time interval, and first condition is satisfied.

It suffices to state that $L = L_a \times L_b$, where L_a and L_b are closed and convex sets defined as follows:

$$L_a = L_b = \left\{ \omega \text{ measurable: } \chi_1(t) \in [0, 1], \chi_2(t) \in [0, 0.95], \chi_3(t) \in [0, 1], \forall t \in [t_0, T_f] \right\}. \quad (87)$$

Hence, by definition of convex, the control set is convex and closed, satisfying second condition.

By definition, each right-hand side of the system (69) is continuous and can be written as a linear function of ω with coefficients depending on time and state. All variables $S, V, E, I, C, U, T, R, B, \chi_1, \chi_2$, and χ_3 are bounded on $[t_0, T_f]$. Using the boundedness of the solution and its positivity, as (69) is bilinear in χ_1, χ_2 , and χ_3 , its right-hand side satisfies condition 3. The integrand in the objective functional (71) is convex on L , and the fourth condition is satisfied.

Finally, it can be easily seen that there exist a constant $\alpha_1 > 1$ and positive numbers μ_1 and μ_2 satisfying

$$K(S, E, I, \chi_1, \chi_2, \chi_3) \leq \mu_2 - \mu_1 \left(|\chi_1|^2 + |\chi_2|^2 + |\chi_3|^2 \right)^{\alpha_1/2}. \quad (88)$$

The Hamiltonian equation is formed accordingly by allowing each adjoint variable to correspond to each state variable, all combined with the objective functional.

Applying Pontryagin's maximum principle, system (69) together with equations (48) and (49) is converted into problem of minimising the Hamiltonian H defined below.

Since necessary conditions that an optimal control and state must satisfy can be generated from Hamiltonian H , see [26].

Hence, the Hamiltonian function H of the control problem of the model will be

$$\begin{aligned} H(S, V, E, I, C, U, T, R, B, \chi_1, \chi_2, \chi_3, \lambda_S, \lambda_V, \lambda_E, \lambda_I, \lambda_C, \lambda_U, \lambda_T, \lambda_R, \lambda_B) \\ = \Theta + \lambda_S \frac{dS}{dt} + \lambda_V \frac{dV}{dt} + \lambda_E \frac{dE}{dt} + \lambda_I \frac{dI}{dt} + \lambda_C \frac{dC}{dt} + \lambda_U \frac{dU}{dt} + \lambda_T \frac{dT}{dt} + \lambda_R \frac{dR}{dt} + \lambda_B \frac{dB}{dt}, \end{aligned} \quad (89)$$

where $\lambda_S, \lambda_V, \lambda_E, \lambda_I, \lambda_C, \lambda_U, \lambda_T, \lambda_R$, and λ_B are the adjoint functions, which can also be the co-state functions with respect to H and

$$\begin{aligned} \Theta &= M_1 S(t) + M_2 E(t) + M_3 I(t) + \frac{1}{2} \left[N_1 (\chi_1(t))^2 + N_2 (\chi_2(t))^2 + N_3 (\chi_3(t))^2 \right], \\ H &= M_1 S(t) + M_2 E(t) + M_3 I(t) + \frac{1}{2} \left(N_1 (\chi_1(t))^2 + N_2 (\chi_2(t))^2 + N_3 (\chi_3(t))^2 \right) \\ &+ \lambda_S \left(q - \left(v_1 (1 - \chi_3(t)) \frac{B(t)}{k + B(t)} S(t) + (1 - \chi_1(t)) (1 - \chi_3(t)) v_2 S(t) I(t) \right) + \omega V(t) + \omega R(t) \right. \\ &- (\chi_2(t) + \delta) S(t) + \lambda_V (\chi_2(t) S(t) - \sigma v_2 V(t) I(t) - (\omega + \delta) V(t)) \\ &+ \lambda_E \left(v_1 (1 - \chi_3(t)) \frac{B(t)}{k + B(t)} S(t) + (1 - \chi_1(t)) (1 - \chi_3(t)) v_2 S(t) I(t) + \sigma v_2 V(t) I(t) - (\xi + \chi_1(t) + \delta) E(t) \right) \\ &+ \lambda_I (\xi E(t) - (m + \varepsilon + \delta) I(t)) + \lambda_C (\chi_1(t) E(t) - (f + \theta + \delta) C(t)) + \lambda_U (f C(t) + (1 - \tau) m I(t) + g_2 T(t)) \\ &- (g_1 + r_1 + \mu + \delta) U(t) + \lambda_T (\tau m I(t) + g_1 U(t) - (g_1 + r_2 + g_2 + \alpha + \delta) T(t)) \\ &+ \lambda_R ((g_1 + r_2) T(t) + r_1 U(t) + \theta C(t) - (\omega + \delta) R(t)) + \lambda_B ((1 - \chi_1(t)) \eta_1 I(t) + (\eta_2 - \beta) B(t)). \end{aligned} \quad (90)$$

Let $S^*, V^*, E^*, I^*, C^*, U^*, T^*, R^*$, and B^* be the optimal state solutions with associated optimal control variables $\chi_1^*, \chi_2^*, \chi_3^*$ for the optimal control of system (69).

To achieve optimal control, the adjoint or co-state functions $\lambda_S, \lambda_V, \lambda_E, \lambda_I, \lambda_C, \lambda_U, \lambda_T, \lambda_R$, and λ_B must satisfy

$$\begin{aligned}\frac{d\lambda_S}{dt} &= -\frac{\partial H}{\partial S}, \\ \frac{d\lambda_V}{dt} &= -\frac{\partial H}{\partial V}, \\ \frac{d\lambda_E}{dt} &= -\frac{\partial H}{\partial E}, \\ \frac{d\lambda_I}{dt} &= -\frac{\partial H}{\partial I}, \\ \frac{d\lambda_C}{dt} &= -\frac{\partial H}{\partial C}, \\ \frac{d\lambda_U}{dt} &= -\frac{\partial H}{\partial U}, \\ \frac{d\lambda_T}{dt} &= -\frac{\partial H}{\partial T}, \\ \frac{d\lambda_R}{dt} &= -\frac{\partial H}{\partial R}, \\ \frac{d\lambda_B}{dt} &= -\frac{\partial H}{\partial B}.\end{aligned}\tag{91}$$

$$\begin{aligned}\frac{d\lambda_S}{dt} &= -M_1 - \lambda_S \left(\frac{-v_1(1-\chi_3)B}{k+B} - (1-\chi_1)(1-\chi_3)v_2I - \chi_2 - \delta \right) - \lambda_V \chi_2 - \lambda_E \left(\frac{v_1(1-\chi_3)B}{k+B} + (1-\chi_1)(1-\chi_3)v_2I \right), \\ \frac{d\lambda_V}{dt} &= -\lambda_S \omega - \lambda_V (-\sigma v_2I - \delta - \omega) - \lambda_E \sigma v_2I, \\ \frac{d\lambda_E}{dt} &= -M_2 - \lambda_E (-\xi - \chi_1 - \delta) - \lambda_I \xi - \lambda_C \chi_1, \\ \frac{d\lambda_I}{dt} &= -M_3 - \lambda_S (1-\chi_1)(1-\chi_3)v_2S + \lambda_V \sigma v_2V - \lambda_E ((1-\chi_1)(1-\chi_3)v_2S + \sigma v_2V) \\ &\quad - \lambda_I (-m - \varepsilon - \delta) - \lambda_U (1-\tau)m - \lambda_T \tau m - \lambda_B (1-\chi_1)\eta_1, \\ \frac{d\lambda_C}{dt} &= -\lambda_C (-f - \theta - \delta) - \lambda_U f - \lambda_R \theta, \\ \frac{d\lambda_U}{dt} &= -\lambda_U (-g_1 - r_1 - \mu - \delta) - \lambda_T g_1 - \lambda_R r_1, \\ \frac{d\lambda_T}{dt} &= -\lambda_U g_2 - \lambda_T (-g_1 - r_2 - g_2 - \alpha - \delta) - \lambda_R (g_1 + r_2), \\ \frac{d\lambda_R}{dt} &= -\lambda_S \omega - \lambda_R (-\omega - \delta), \\ \frac{d\lambda_B}{dt} &= -\lambda_S \left(\frac{-v_1(1-\chi_3)S}{k+B} + \frac{v_1(1-\chi_3)BS}{(k+B)^2} \right) - \lambda_E \left(\frac{v_1(1-\chi_3)S}{k+B} - \frac{v_1(1-\chi_3)BS}{(k+B)^2} \right) - \lambda_B (\eta_2 - \beta).\end{aligned}\tag{92}$$

4.2. *Optimality Equations of the Model's Controls.* Partial derivative of the Hamiltonian with respect to each

admissible control is all equal to zero, ease solving the optimal controls; thus, □

$$\begin{aligned}
\Rightarrow \frac{\partial H}{\partial \chi_1} &= N_1 \chi_1 + \lambda_S (1 - \chi_3) v_2 S I + \lambda_E (-(1 - \chi_3) v_2 S I - E) - \lambda_B \eta_1 I = 0, \\
\Rightarrow \chi_1^* &= \frac{\chi_3 \lambda_S v_2 S^{**} I^{**} - \chi_3 \lambda_E v_2 S^{**} I^{**} - \lambda_S v_2 S^{**} I^{**} + \lambda_V v_2 S^{**} I^{**} + \eta_1 \lambda_B I^{**} + \lambda_E E^{**}}{N_1}, \\
\Rightarrow \frac{\partial H}{\partial \chi_2} &= N_2 \chi_2 - \lambda_S S + \lambda_V S, \\
\Rightarrow \chi_2^* &= \frac{S^{**} (\lambda_S - \lambda_V)}{N_2}, \\
\Rightarrow \frac{\partial H}{\partial \chi_3} &= N_3 \chi_3 + \lambda_S \left(\frac{v_1 B S}{k + B} + (1 - \chi_1) v_2 S I \right) + \lambda_C E + \lambda_E \left(\frac{-v_1 B S}{k + B} - (1 - \chi_1) v_2 S I \right), \\
\Rightarrow \chi_3^* &= \frac{1}{(k + B) N_3} (\chi_1 k v_2 S^{**} I^{**} \lambda_S - \chi_1 k v_2 S^{**} I^{**} \lambda_E \chi_1 v_2 S^{**} I^{**} B^{**} \lambda_S - \chi_1 v_2 S^{**} I^{**} B^{**} \lambda_E k v_2 S^{**} I^{**} \lambda_S \\
&\quad + k v_2 S^{**} I^{**} \lambda_E - v_2 S^{**} I^{**} B^{**} \lambda_S + v_2 S^{**} I^{**} B^{**} \lambda_E - v_1 S^{**} B^{**} \lambda_S + v_1 S^{**} B^{**} \lambda_E - k E^{**} \lambda_C - E^{**} B^{**} \lambda_C).
\end{aligned} \tag{93}$$

Now, $a_1 \leq \chi_1 \leq b_1$, $a_2 \leq \chi_2 \leq b_2$, and $a_3 \leq \chi_3 \leq b_3$.
The characterisation is as follows:

where

$$\begin{aligned}
\chi_1^* &= \begin{cases} a_1, & \text{when } \bar{\chi}_1 \leq a_1, \\ \bar{\chi}_1, & \text{when } a_1 < \bar{\chi}_1 < b_1, \\ b_1, & \text{when } \bar{\chi}_1 \geq b_1. \end{cases} \\
\chi_2^* &= \begin{cases} a_2, & \text{when } \bar{\chi}_2 \leq a_2, \\ \bar{\chi}_2, & \text{when } a_2 < \bar{\chi}_2 < b_2, \\ b_2, & \text{when } \bar{\chi}_2 \geq b_2. \end{cases} \\
\chi_3^* &= \begin{cases} a_3, & \text{when } \bar{\chi}_3 \leq a_3, \\ \bar{\chi}_3, & \text{when } a_3 < \bar{\chi}_3 < b_3, \\ b_3, & \text{when } \bar{\chi}_3 \geq b_3. \end{cases}
\end{aligned} \tag{94}$$

$$\bar{\chi}_1 = \frac{((\chi_3 - 1) v_2 S^{**} I^{**}) \lambda_S + (E^{**} - \chi_3 S^{**} I^{**}) \lambda_E + v_2 S^{**} I^{**} \lambda_V + \eta_1 I^{**} \lambda_B}{N_1},$$

$$\bar{\chi}_2 = \frac{S^{**} (\lambda_S - \lambda_V)}{N_2}, \tag{95}$$

$$\bar{\chi}_3 = \frac{((\chi_1 k + \chi_1 B^{**} - k - B^{**}) v_2 S^{**} I^{**} - v_1 S^{**} B^{**}) \lambda_S + (B^{**} - \chi_1 k - \chi_1 B^{**} - k) v_2 S^{**} I^{**} \lambda_E}{(k + B^{**}) N_3},$$

5. Numerical Simulations of the Model

$$\begin{aligned}
\chi_1^*(t) &= \max(0, \min(\bar{\chi}_1(t), 1)), \\
\chi_2^*(t) &= \max(0, \min(\bar{\chi}_2(t), 0.95)), \\
\chi_3^*(t) &= \max(0, \min(\bar{\chi}_3(t), 1)).
\end{aligned} \tag{96}$$

The numerical algorithm that simulates the optimal control of system (69) is presented below using a semi-implicit finite-difference method. This method is known as improved Gauss–Seidel-like implicit finite-difference method, and it was introduced by [27] and denoted it as GSS1. It was successfully applied by [5, 28].

Time interval $[t_0, T_f]$ where $t_0 = 0$ is discretely calibrated into points $t_i = ih + t_0$ ($i = 0, 1, \dots, n$), where h is the step. State and adjoint variables together with controls are defined in terms of nodal points.

State variables $S(t), V(t), E(t), I(t), C(t), U(t), T(t), R(t)$, and $B(t)$ have nodal points $S_i, V_i, E_i, I_i, C_i, U_i, T_i, R_i$, and B_i .

Adjoint variables $\lambda_1(t), \lambda_2(t), \lambda_3(t), \lambda_4(t), \lambda_5(t), \lambda_6(t), \lambda_7(t), \lambda_8(t)$, and $\lambda_9(t)$ have nodal points $\lambda_{1,i}, \lambda_{2,i}, \lambda_{3,i}, \lambda_{4,i}, \lambda_{5,i}, \lambda_{6,i}, \lambda_{7,i}, \lambda_{8,i}$, and $\lambda_{9,i}$, and controls $\chi_1(t)$,

$\chi_2(t)$, and $\chi_3(t)$ have nodal points $\chi_{1,i}, \chi_{2,i}$, and $\chi_{3,i}$ with T_f as the final time. The approximation of first-order time derivative $dS(t)/dt$ can be numerically given as follows:

$$\frac{dS(t)}{dt} = \lim_{h \rightarrow \infty} \frac{S(t+h) - S(t)}{h}. \quad (97)$$

Using the GSS1 method, the forward-difference approximation of this optimal control problem is as follows:

$$\begin{aligned} S_{i+1} &= \frac{S_i + h(q + \omega V_i + \omega R_i)}{1 + h((v_1(1 - \chi_{3i})B_i)/(k + B_i) - (1 - \chi_{1i})(1 - \chi_{3i})v_2I_i + \chi_{2i} + \delta)}, \\ V_{i+1} &= \frac{V_i + h\chi_{2i}S_{i+1}}{1 + h(\sigma v_2I_{i+1} + \omega + \delta)}, \\ E_{i+1} &= \frac{E_i + h(((v_1(1 - \chi_{3i})B_iS_{i+1})/(k + B_i)) + (1 - \chi_{1i})(1 - \chi_{3i})v_2I_iS_{i+1} + \sigma v_2V_{i+1}I_i)}{1 + h(\xi + \chi_{1i} + \delta)}, \\ I_{i+1} &= \frac{I_i + h\xi E_{i+1}}{1 + h(m + \varepsilon + \delta)}, \\ C_{i+1} &= \frac{C_i + h(1 - \chi_{1i})E_{i+1}}{1 + h(f + \theta + \delta)}, \\ U_{i+1} &= \frac{U_i + h(fC_{i+1} + (1 - \tau)mI_{i+1} + g_2T_i)}{1 + h(g_1 + r_1 + \mu + \delta)}, \\ T_{i+1} &= \frac{T_i + h(\tau mI_{i+1} + g_1U_{i+1})}{1 + h(g_1 + r_2 + g_2 + \alpha + \delta)}, \\ R_{i+1} &= \frac{R_i + h((g_1 + r_2)T_{i+1} + r_1U_{i+1} + \theta C_{i+1})}{1 + h(\omega + \delta)}, \\ B_{i+1} &= \frac{B_i + h(1 - \chi_{1i})\eta_1I_{i+1}}{1 - h(\eta_2 - \beta)}. \end{aligned} \quad (98)$$

The backward-difference is obtained using similar technique as follows:

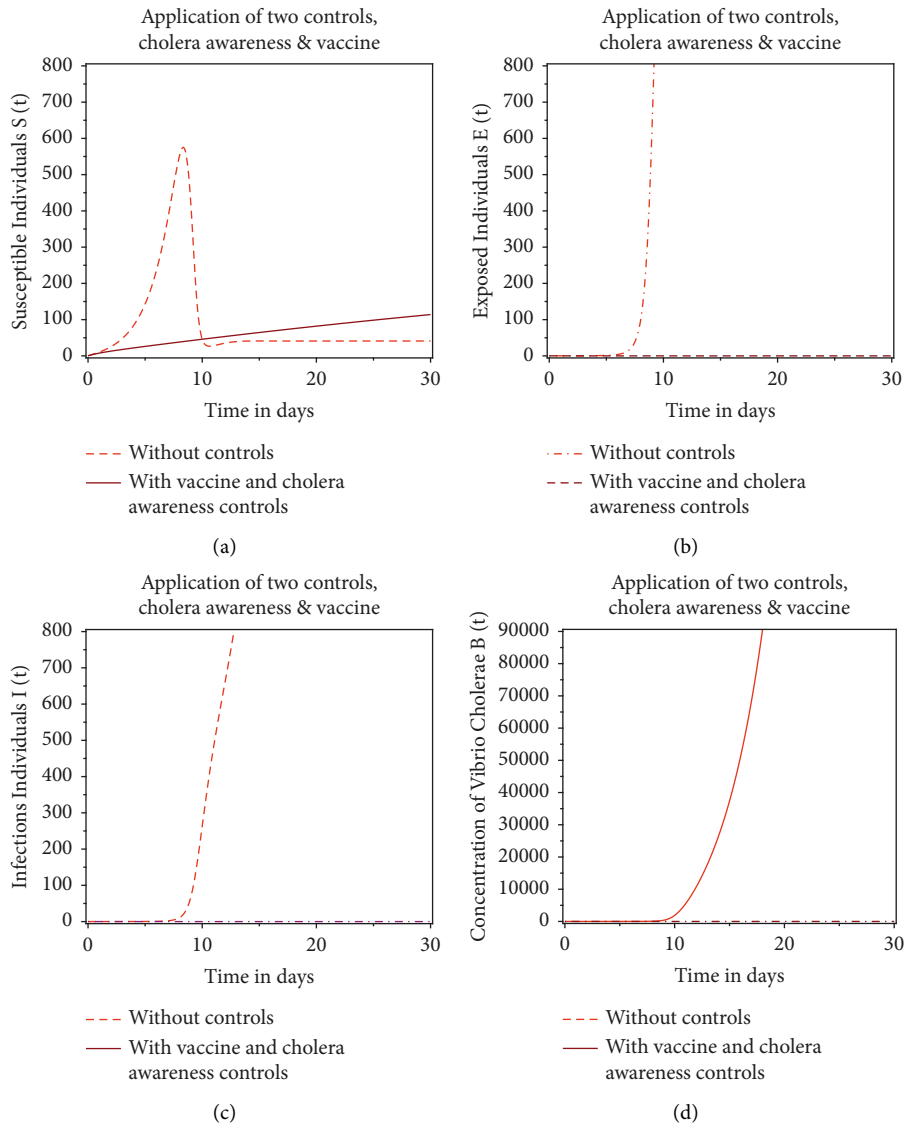

FIGURE 3: Effect of application of vaccine and cholera awareness programme as controls on susceptible, exposed, infected, and *Vibrio cholerae* population.

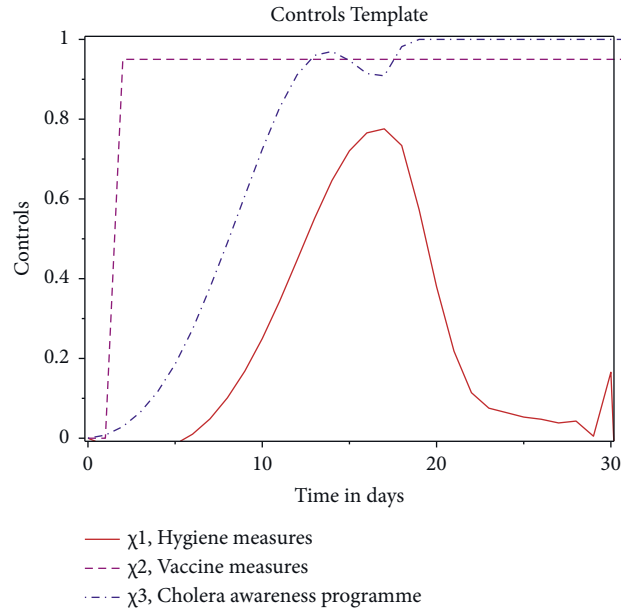

FIGURE 4: Template of the optimised controls, a combination of the controls for cholera.

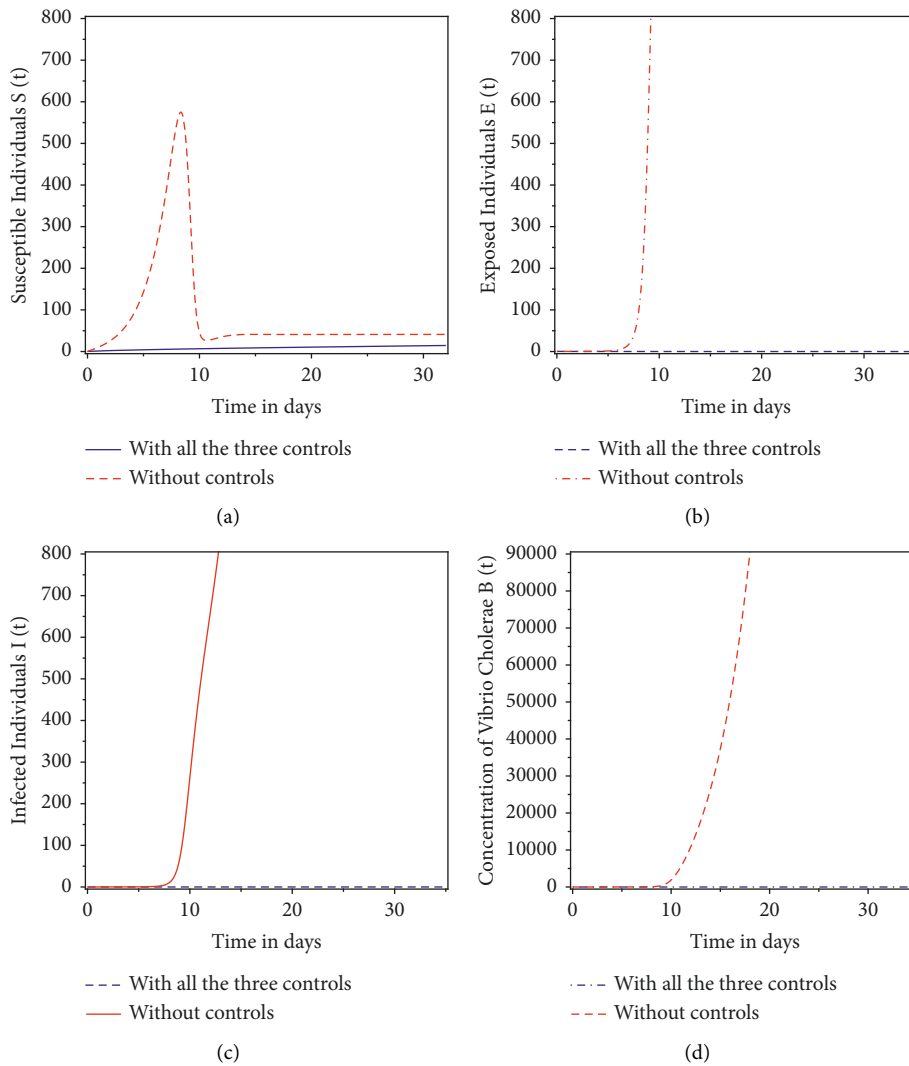

FIGURE 5: Effect of all the three controls on susceptible, exposed, infected, and *Vibrio cholerae* population.

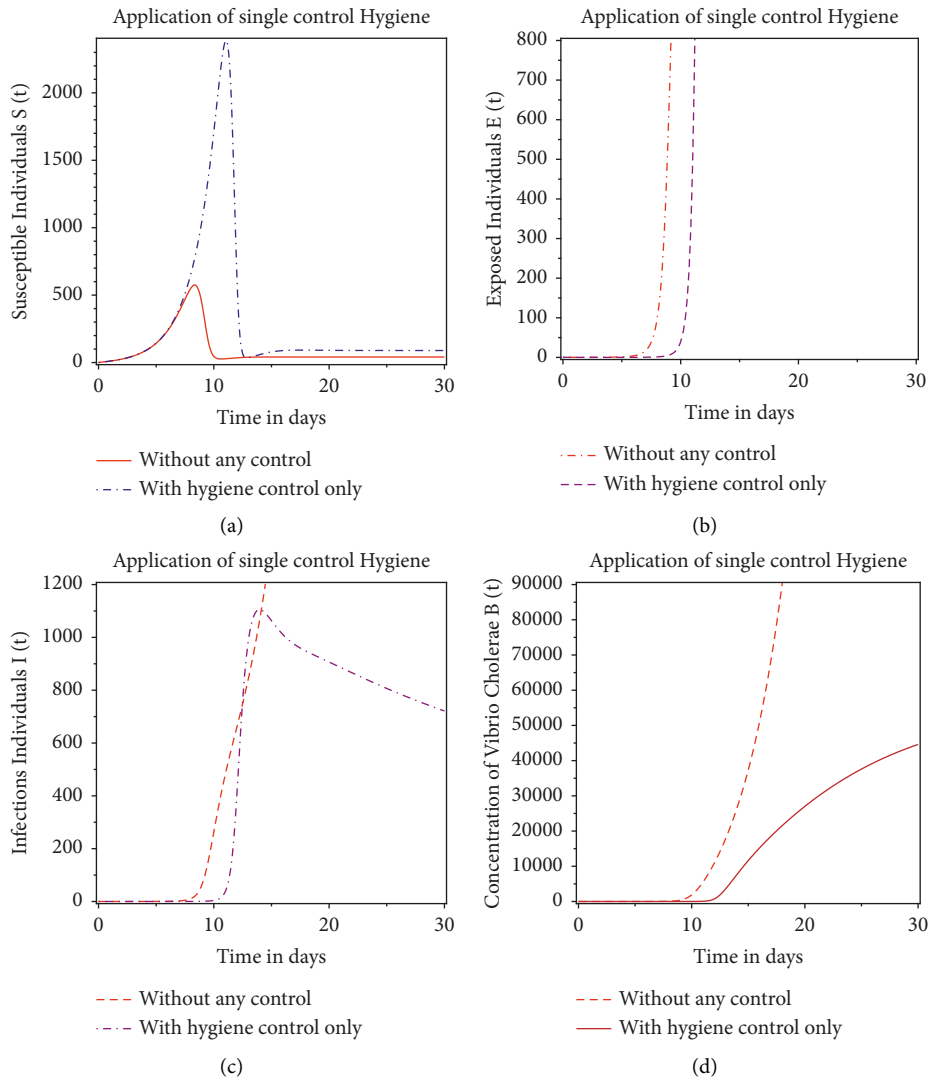

FIGURE 6: Effect of application of only hygiene control on susceptible, exposed, infected, and *Vibrio cholerae* population.

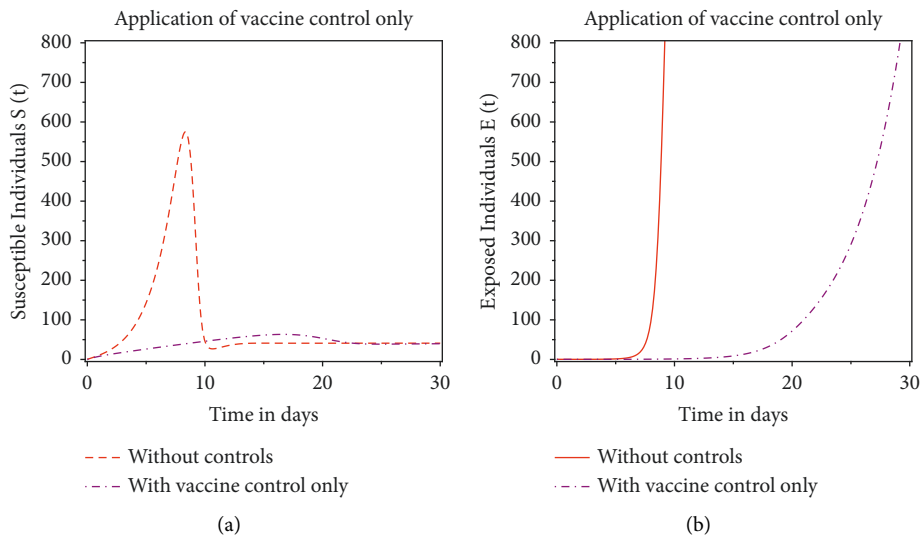

FIGURE 7: Continued.

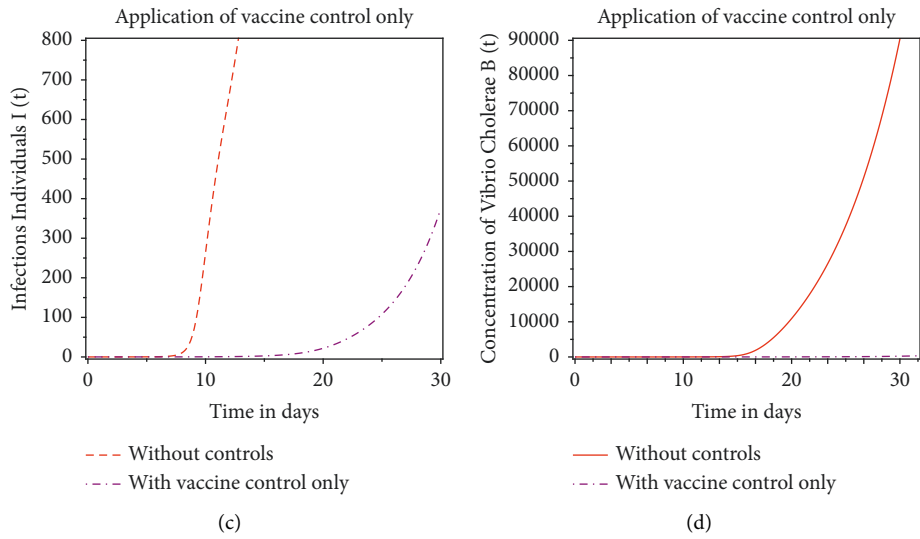

FIGURE 7: Effect of application of only vaccine control on susceptible, exposed, infected, and *Vibrio cholerae* population.

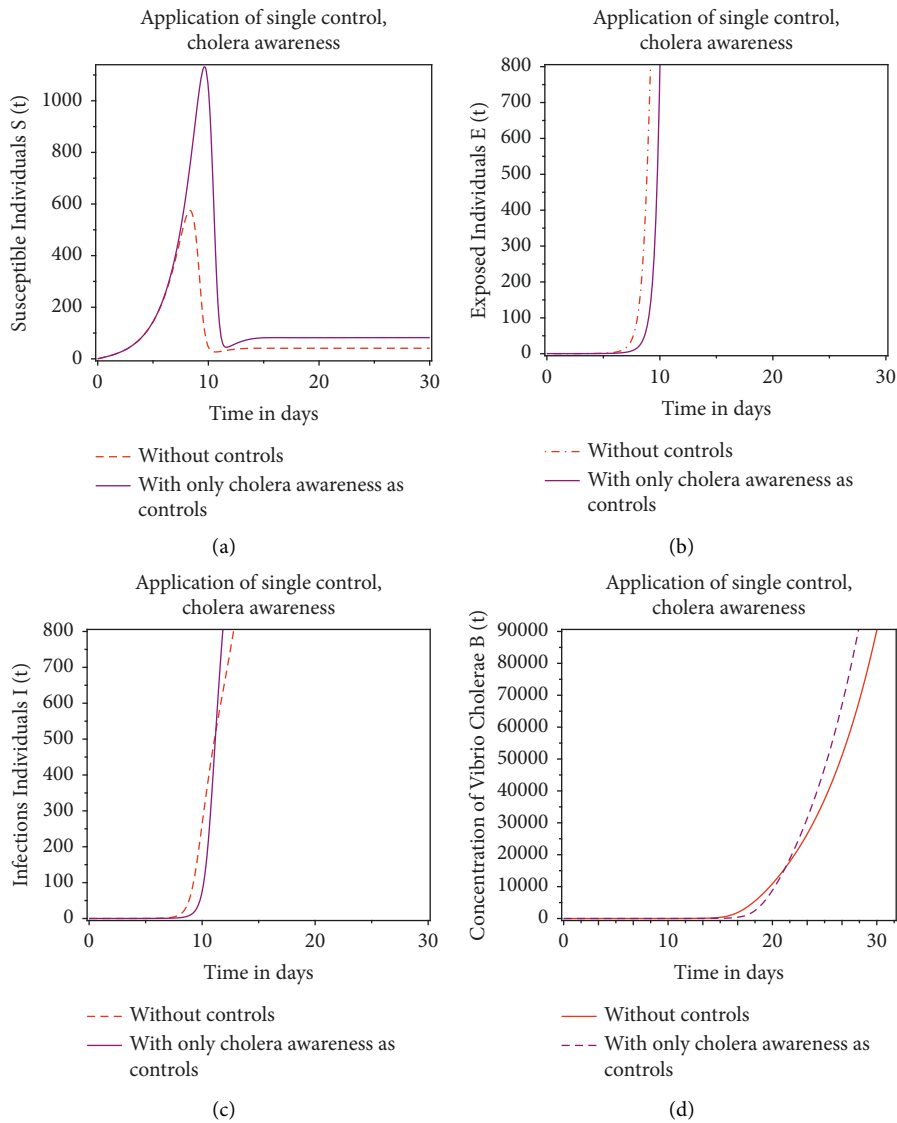

FIGURE 8: Effect of application of only cholera awareness programme as control on susceptible, exposed, infected, and *Vibrio cholerae* population.

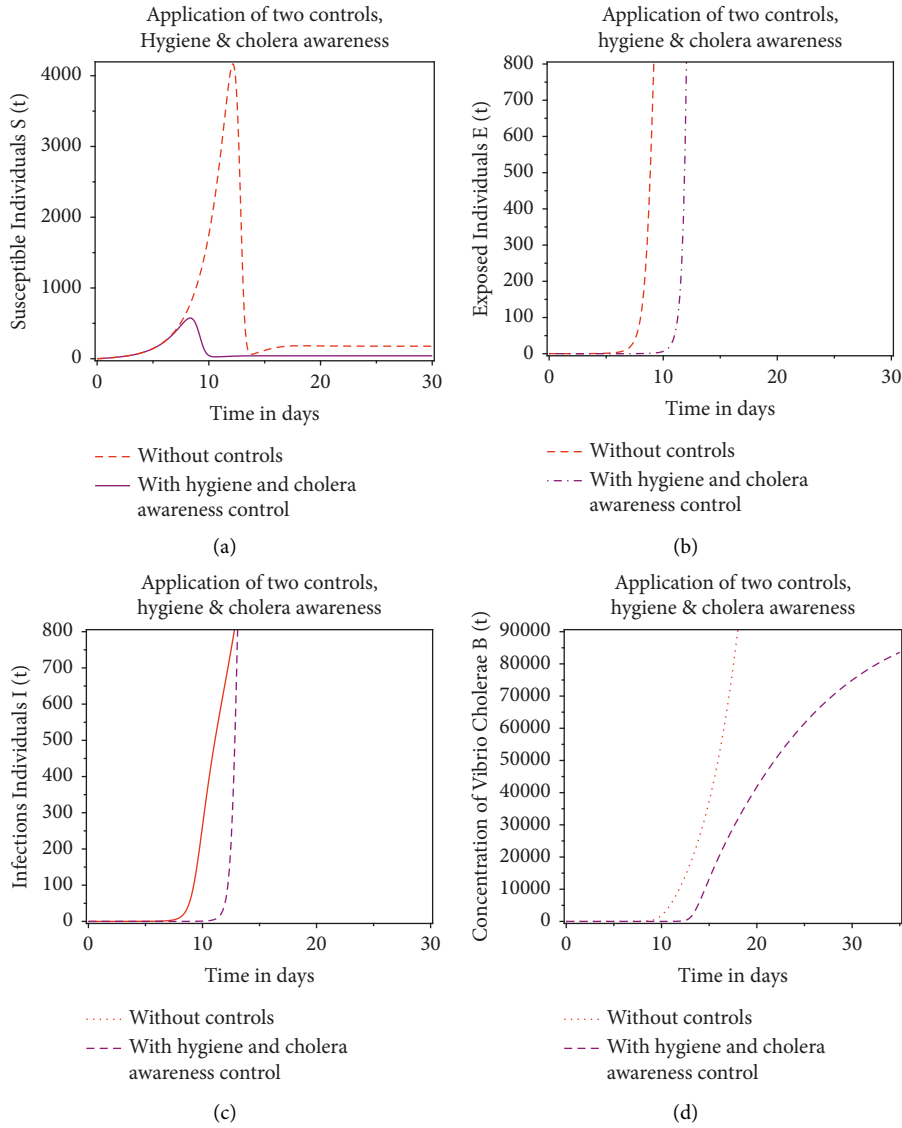

FIGURE 9: Effect of application of hygiene and cholera awareness programme as controls on susceptible, exposed, infected, and *Vibrio cholerae* population.

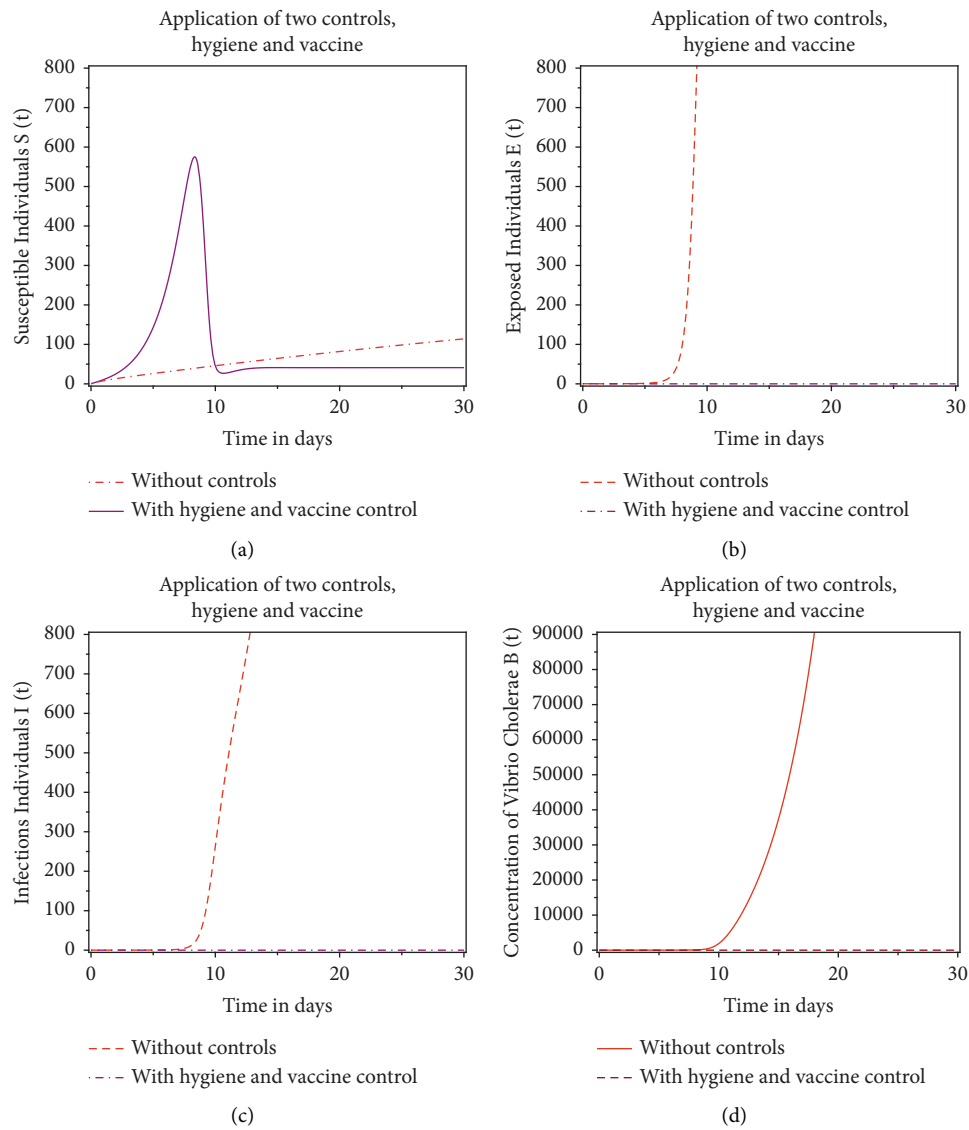

FIGURE 10: Effect of application of hygiene and vaccine as controls on susceptible, exposed, infected, and *Vibrio cholerae* population.

$$\begin{aligned}
\lambda_{1,n-i-1} &= \frac{\lambda_{1,n-i} + h(-M_1 - \lambda_{2,n-i}\chi_{2i} - \lambda_{3,n-i}((v_1(1-\chi_{3i})B_i)/(k+B_i) + (1-\chi_{1i})(1-\chi_{3i})v_2I_i))}{1 + h((-v_1(1-\chi_{3i})B_i)/(k+B_i) - (1-\chi_{1i})(1-\chi_{3i})v_2I_i - \chi_{2i} - \delta)}, \\
\lambda_{2,n-i-1} &= \frac{\lambda_{2,n-i} - h(\lambda_{1,n-i}\omega - \lambda_{3,n-i}\sigma v_2I_i)}{1 - h(\sigma v_2I_i + \omega + \delta)}, \\
\lambda_{3,n-i-1} &= \frac{\lambda_{3,n-i} + h(-M_2 - \lambda_4\xi - \lambda_5\chi_{1i})}{1 + h(-\xi - \chi_{1i} - \delta)}, \\
\lambda_{4,n-i-1} &= \frac{\lambda_{4,n-i} + h(-M_3 + (\lambda_{1,n-i-1} - \lambda_{3,n-i-1})(1-\chi_{1i})(1-\chi_{3i})v_2S_{i+1})}{1 + h(-m - \varepsilon - \delta)} \\
&\quad + \frac{h(\sigma v_2V_{i+1}(\lambda_{2,n-i} - \lambda_{3,n-i-1}) - \lambda_{6,n-i}(1-\tau)m - \lambda_{7,n-i}\tau m)}{1 + h(-m - \varepsilon - \delta)} - \frac{h\lambda_{9,n-i}(1-\chi_{1i})\eta_1}{1 + h(-m - \varepsilon - \delta)}, \\
\lambda_{5,n-i-1} &= \frac{\lambda_{5,n-i} - h(\lambda_{6,n-i}f + \lambda_{8,n-i}\theta)}{1 - h(f + \theta + \delta)}, \\
\lambda_{6,n-i-1} &= \frac{\lambda_{6,n-i} - h(\lambda_{7,n-i}g_1 + \lambda_{8,n-i}r_1)}{1 - h(g_1 + r_1 + \mu + \delta)}, \\
\lambda_{7,n-i-1} &= \frac{\lambda_{7,n-i} - h(\lambda_{6,n-i}g_2 + \lambda_{8,n-i}(g_1 + r_2))}{1 - h(g_1 + r_2 + g_2 + \alpha + \delta)}, \\
\lambda_{8,n-i-1} &= \frac{\lambda_{8,n-i} - \lambda_{1,n-i}h\omega}{1 - h(\omega + \delta)}, \\
\lambda_{9,n-i-1} &= \frac{\lambda_{9,n-i}}{1 + h(\eta_2 - \beta)} + \frac{\lambda_{1,n-i}h((-v_1(1-\chi_{3i})S_i)/(k+B_i) + (v_1(1-\chi_{3i})B_iS_i)/((k+B_i)^2))}{1 + h(\eta_2 - \beta)} \\
&\quad - \frac{\lambda_{3,n-i}h(((v_1(1-\chi_{3i})S_i)/(k+B_i)) - ((v_1(1-\chi_{3i})B_iS_i)/((k+B_i)^2)))}{1 + h(\eta_2 - \beta)}.
\end{aligned} \tag{99}$$

The initial values of the state variables of system (46) used in the simulation are as follows: $S(0) = 0.3$, $V(0) = 0.3333$, $E(0) = 0.0833$, $I(0) = 0.0167$, $C(0) = 0.1667$, $U(0) = 0.0127$, $T(0) = 0.0037$, $R(0) = 0.0163$, $B(0) = 0.0006$.

Values of the parameters used in the simulations are in Table 2, with exception of the values of controls $\chi_1 = h$, $\chi_2 = \psi$, and $\chi_3 = \chi$. Time T_f used in the model is fixed at 35 days in the simulation of optimal control graphs except Figure 3(a), whose maximum value is 25 days. Values of weighting constants are as follows: $M_1 = 900$, $M_2 = 100$, $M_3 = 38$, $N_1 = 145$, $N_2 = -1$, and $N_3 = 32$. The graphs from simulations of the model of system of equation (69) here are used to display the impact of the control measures on four state variables: susceptible, exposed, infected, and population of *Vibrio cholerae*.

See Figure 4 shows the template of the three controls. Figure 5 displays impact of the three controls on susceptible, and it shows how the controls reduce population of

susceptible to below 20 throughout the period of 35 days, but without the controls, population of the susceptible rise up to 900 in less than 10 days of the onset of the disease.

Figures 6–8 show how the three controls reduced population of the exposed, infected, and *Vibrio cholerae* population. On the other hand without controls, the population of the exposed, infected, and the *Vibrio cholerae* rises 150000, 60000, and 100000, respectively.

6. Summary and Conclusion

The study has succeeded in obtaining the model's threshold R_0 and the most sensitive parameters in it; The interpretation of the figures and conclusion shows the final result.

6.1. Summary. The model's basic reproduction number is as follows:

$$R_0 = \frac{q((1-\chi)(1-h)(\omega+\delta)\beta k v_2 - (1-\chi)(1-h)(\omega+\delta)\eta_2 k v_2 + (1-\chi)(1-h)(\omega+\delta)\eta_1 v_1 + \beta k \psi \sigma v_2 - \eta_2 k \psi \sigma v_2)}{((\psi+\delta)(\omega+\delta) - \omega \psi)k(m+\varepsilon+\delta)(\beta-\eta_2)}. \tag{100}$$

The most sensitive parameters in this obtained R_0 are h and v_2 , increasing h , which denotes hygiene consciousness of individuals will definitely reduce the spread of *Vibrio cholerae*, which will in turn reduce rate of contracting cholera disease. Since reducing R_0 implies making it less than unity, this is interpreted as “the disease reduces and dies out.” Increasing R_0 is increasing *Vibrio cholerae*, thereby spreading it to many individuals. On the other hand, v_2 denotes the rate of getting *Vibrio cholerae* through human-to-human interaction and its sensitivity index value is a positive, that is, 0.9978. Increasing it by 10% will increase R_0 by 9.978%. Literally increasing rate of ingesting *Vibrio cholerae* will definitely increase R_0 , the increment that will make it greater than unity, which implies escalation of the disease and persistence.

Simulations of SVEICUTRB model displayed in graphs show the impact of the control measures on four state variables: susceptible, exposed, infected, and population of *Vibrio cholerae*. Though [29] suggested the need to eradicate epidemics and its spread using appropriate measures in approximately 40 days, Figure 4 shows a template of the three controls the model use: hygiene consciousness, cholera vaccine, and cholera awareness programme. Impact of the three controls on four of the nine state variables of the model was presented as follows. Figure 5(a) shows how the controls reduce population of susceptible to zero throughout the period of 35 days, but without the controls, population of the susceptible rises up to 900 in less than 10 days of the onset of the disease. Figures 5(b)–5(d) show how the three controls reduced population of the exposed, infected, and *Vibrio cholerae* population. On the other hand, without controls, the population of the exposed, infected, and the *Vibrio cholerae* bacteria rises infinitely.

Figures 6(a)–6(d) show results of applying only one control “hygiene consciousness,” compared with when no control is used. The outcome shows that using the single control alone will increase the population of susceptible from 1000 when there is no control applied to 4000. Applying hygiene consciousness alone can suppress the population of the exposed, infected, and cholera pathogens (*Vibrio cholerae* bacteria).

Using single control “cholera vaccine” alone, results in Figures 7(a)–7(d) were obtained. Administering cholera vaccine as the only control for cholera can reduce the number of susceptible, exposed, rate of infection, and population of *Vibrio cholerae* bacteria to zero. It is hence an effective measure of eradicating cholera. Cholera awareness programme administered alone yields the results in Figures 8(a)–8(d). Application of single control ‘cholera awareness’ alone and not applying any control at all seem to give the same result. The graphs show that population of the susceptible, exposed, infected, and *Vibrio cholerae* bacteria will increase the same way, when no controls were adopted. The population of susceptible will even increase the more, because cholera awareness programme is a preventive measure, not curative.

Application of two controls, hygiene measures and cholera awareness programme, gives result in Figures 9(a)–9(d). Figure 9(a) shows how susceptible individuals increase

up to 5000 individuals, which is five times more than when there is no administered control. Application of two controls generally reduced exposed and infected individuals and population of *Vibrio cholerae* bacteria. In particular, two controls, hygiene measures and cholera vaccine, as shown in Figures 10(a)–10(d) show how the two controls were able to reduce number of susceptible, exposed, and infected individuals and population of *Vibrio cholerae* bacteria to a very small rate that is less than when no control is administered. Figures 3(a)–3(d) also display two controls: cholera vaccine and awareness programme; they show how the two controls reduced number of susceptible, exposed, and infected individuals and reduced the number of *Vibrio cholerae* bacteria population.

6.2. Conclusion. Effects of the controls on susceptible, exposed, and infected individuals together with population of cholera pathogens were obtained and plotted. The effects show that the fastest way to control cholera quickly and effectively is application of all the three controls, at least above average rates.

6.3. Recommendations. After treatment measures, application of cholera vaccines, hygiene, and cholera awareness programmes are the best measures of preventing the spread of cholera and entire full control of the disease. Keeping hygiene consciousness rate always high and hindering ingestion of *Vibrio cholerae* bacteria by any means to keep its rate zero will surely prevent cholera disease. This has been justified by the model’s R_0 .

Data Availability

The values of variables and parameters data used to support the findings of this study are included within the article.

Conflicts of Interest

The authors declare that they have no conflicts of interest.

Acknowledgments

This study was supported in part of S. F. Abubakar’s Ph.D. thesis. The authors acknowledge the contribution of Kebbi State University of Science and Technology, Aliero, for sponsoring the Ph.D. course.

References

- [1] D. Ganesan, S. S. Gupta, and D. Legros, “Cholera surveillance and estimation of burden of cholera,” *Vaccine*, vol. 38, 2020.
- [2] P. E. Idoga, M. Toycon, and M. A. Zayyad, “Analysis of factors contributing to the spread of cholera in developing countries,” *The Eurasian Journal of Medicine*, vol. 51, no. 2, pp. 121–127, 2019.
- [3] R. Llanes, L. Somarriba, G. Hernández, Y. Bardají, A. Aguila, and R. N. Mazumder, “Low detection of vibrio cholerae carriage in healthcare workers returning to 12 Latin american

- countries from Haiti,” *Epidemiology and Infection*, vol. 143, no. 5, pp. 1016–1019, 2015.
- [4] M. Momba and M. Azab El-Liethy, *Vibrio cholerae and Cholera Biotypes*, Global Water Pathogen Project, Pretoria, South Africa, 2018.
- [5] K. Hattaf, M. Rachik, S. Saadi, Y. Tabit, and N. Yousfi, “Optimal control of tuberculosis with exogenous reinfection,” *Applied Mathematical Sciences*, vol. 3, no. 5, pp. 231–240, 2009.
- [6] R. L. Miller Neilan, E. Schaefer, H. Gaff, K. R. Fister, and S. Lenhart, “Modeling optimal intervention strategies for cholera,” *Bulletin of Mathematical Biology*, vol. 72, no. 8, pp. 2004–2018, 2010.
- [7] H. Namawejje, E. Obuya, and L. S. Luboobi, “Modeling optimal control of cholera disease under the interventions of vaccination, treatment and education awareness,” *Journal of Mathematics Research*, vol. 10, no. 5, 2018.
- [8] P. Panja, “Optimal control analysis of a cholera epidemic model,” *Biophysical Reviews and Letters*, vol. 14, no. 01, pp. 27–48, 2019.
- [9] M. Javidi and B. Ahmad, “A study of a fractional-order cholera model,” *Applied Mathematics & Information Sciences*, vol. 8, no. 5, pp. 2195–2206, 2014.
- [10] E. Lamond and J. Kinyanjui, *Cholera Outbreak Guidelines: Preparedness, Prevention and Control*, Oxfam GB, Oxford, United Kingdom, 2012.
- [11] M. J. Ochoche, E. C. Madubueze, and T. B. Akaabo, “A mathematical model on the control of cholera: hygiene consciousness as a strategy,” *The Journal of Mathematics and Computer Science*, vol. 5, no. 2, pp. 172–187, 2015.
- [12] J. Wu, R. Dhingra, M. Gambhir, and J. V. Remais, “Sensitivity analysis of infectious disease models: methods, advances and their application,” *Journal of The Royal Society Interface*, vol. 10, no. 86, 2013.
- [13] A. O. Isere, J. E. Osemwenkhae, and D. Okuonghae, “Optimal control model for the outbreak of cholera in Nigeria,” *African Journal of Mathematics and Computer Science Research*, vol. 7, no. 2, pp. 24–30, 2014.
- [14] S. Edward and N. Nyerere, “A mathematical model for the dynamics of cholera with control measures,” *Applied and Computational Mathematics*, vol. 4, no. 2, p. 53, 2015.
- [15] M. Elhia, A. Laaroussi, M. Rachik, Z. Rachik, and E. Labriji, “Global stability of a susceptible-infected-recovered (sir) epidemic model with two infectious stages and treatment,” *International Journal of Science and Research*, vol. 3, no. 5, pp. 114–121, 2014.
- [16] S. Liao and W. Yang, “On the dynamics of a vaccination model with multiple transmission ways,” *International Journal of Applied Mathematics and Computer Science*, vol. 23, no. 4, pp. 761–772, 2013.
- [17] T. H. Gronwall, “Note on the derivatives with respect to a parameter of the solutions of a system of differential equations,” *Annals of Mathematics*, vol. 20, no. 4, 1919.
- [18] P. Mafuta, J. Mushanyu, and G. Nhawu, “Invariant region, endemic equilibria and stability analysis,” *IOSR Journal of Mathematics*, vol. 10, no. 2, pp. 118–120, 2014.
- [19] P. Van den Driessche and J. Watmough, “Reproduction numbers and sub-threshold endemic equilibria for compartmental models of disease transmission,” *Mathematical Biosciences*, vol. 180, no. 1–2, pp. 29–48, 2002.
- [20] O. Diekmann, J. A. P. Heesterbeek, and J. A. Metz, “On the definition and the computation of the basic reproduction ratio R_0 in models for infectious diseases in heterogeneous populations,” *Journal of Mathematical Biology*, vol. 28, no. 4, pp. 365–382, 1990.
- [21] D. Hincapié-Palacio, J. Ospina, and D. F. M. Torres, “Approximated analytical solution to an ebola optimal control problem,” *International Journal for Computational Methods in Engineering Science and Mechanics*, vol. 17, no. 5–6, pp. 382–390, 2016.
- [22] G. Birkhoff and G. C. Rota, *Ordinary Differential Equations*, Ginn, Boston, 1989.
- [23] M. Elhia, M. Rachik, and E. Benlahmar, “Optimal control of an sir model with delay in state and control variables,” *International Scholarly Research Notices*, 403549, vol. 2013, 7 pages, 2013.
- [24] W. H. Fleming and R. W. Rishel, “Deterministic and stochastic optimal control,” *Springer Science & Business Media*, vol. 1, 2012.
- [25] S. Isaac Oke, M. B. Matadi, and S. S. Xulu, “Optimal control analysis of a mathematical model for breast cancer,” *Mathematical and Computational Applications*, vol. 23, no. 2, 2018.
- [26] S. Lenhart and J. T. Workman, *Optimal Control Applied to Biological Models*, Chapman and Hall/CRC, London, UK, 2007.
- [27] A. Gumel, P. Shivakumar, and B. Sahai, “A mathematical model for the dynamics of hiv-1 during the typical course of infection,” *Nonlinear Analysis: Theory, Methods & Applications*, vol. 47, no. 3, pp. 1773–1783, 2001.
- [28] J. Karrakchou, M. Rachik, and S. Gourari, “Optimal control and infectiology: application to an hiv/aids model,” *Applied Mathematics and Computation*, vol. 177, no. 2, pp. 807–818, 2006.
- [29] A. P. Lemos-Paião, C. J. Silva, D. F. M. Torres, and E. Venturino, “Optimal control of aquatic diseases: a case study of Yemen’s cholera outbreak,” *Journal of Optimization Theory and Applications*, vol. 185, no. 3, pp. 1008–1030, 2020.