

Research Article

Improving the Comfort of the Vehicle Based on Using the Active Suspension System Controlled by the Double-Integrated Controller

Tuan Anh Nguyen 

Automotive Engineering Department, Thuyloi University, 175 Tay Son, Dong Da, Hanoi, Vietnam

Correspondence should be addressed to Tuan Anh Nguyen; anhngtu@tlu.edu.vn

Received 28 May 2021; Revised 5 July 2021; Accepted 29 August 2021; Published 6 September 2021

Academic Editor: Mohamed A. A. Abdelkareem

Copyright © 2021 Tuan Anh Nguyen. This is an open access article distributed under the Creative Commons Attribution License, which permits unrestricted use, distribution, and reproduction in any medium, provided the original work is properly cited.

When the vehicle moves on the road, many external factors affect the vehicle. These effects can cause oscillation and instability for the vehicle. The oscillation of the vehicle directly affects the safety and comfort of passengers. The suspension system is used to control and extinguish these oscillations. However, the conventional passive suspension system is unable to fully meet the vehicle's requirements for stability and comfort. To improve these problems, there are many modern suspension system models that have been used in the vehicle to replace the passive suspension system. The modern suspension systems are used as the air suspension system, semiactive suspension system, and active suspension system. These systems which are controlled automatically by the controller were established based on the control methods. There are a lot of control methods which are used to control the operation of the active suspension system. These methods have their advantages and disadvantages. Almost, conventional control methods such as PID, LQR, or SMC are commonly used. However, they do not provide optimal efficiency in improving a vehicle's oscillation. Therefore, it is necessary to establish a novel solution for the active suspension system control to improve the vehicle's oscillation. In this paper, the method of using the double-integrated controller is proposed to solve the above problem. The double-integrated controller consists of two hydraulic actuators which are controlled completely separately. This is a completely novel and original method that can provide positive effects. This research focuses on establishing, simulating, and evaluating the novel control method (the double-integrated control) for the active suspension system. The results of the research have shown that when the vehicle is equipped with the active suspension system which is controlled by the double-integrated controller, the maximum values of displacement and acceleration of the sprung mass are significantly reduced. They reach only 6.25% and 9.10% (case 1) and 6.00% and 6.12% (case 2) compared to the conventional passive suspension system. Besides, its average values which are calculated by RMS are only about 3.91% and 4.67% (case 1) and 4.48% and 4.77% (case 2) compared to the above case. Therefore, the comfort and stability of the vehicle have been improved. This paper provides new concepts and knowledge about the double-integrated control method which will become the trend to be used in the next time for the systems of the vehicle. In the future, experimental procedures also need to be conducted to be able to more accurately evaluate the results of this research.

1. Introduction

The automobile is a popular vehicle over the world. This vehicle is widely used by everyone for many purposes. With the development of science, engineering, and technology, the demands of the vehicle are increasing. When the vehicle moves on the road, this vehicle can suffer a lot of external impacts. These impacts affect the stability and safety of passengers and cargoes on the vehicle.

The oscillation of the vehicle is one of the very important issues affecting the health and comfort of passengers. Almost, the vehicle's oscillation is derived from the bump on the road. Besides, other factors such as lateral wind, steering, and acceleration also cause undesired oscillations. There are many criteria used to evaluate the vehicle's stability and comfort, such as acceleration of the vehicle body (sprung mass), displacement of the vehicle body (sprung mass), and vertical force at wheels F_z . If these values are within the

permissible range, the vehicle's stability and comfort will be guaranteed.

The suspension system of the vehicle is used to ensure the stability and safety of the vehicle while moving on the road. The suspension system is the soft link between the wheel and the body which separates the vehicle into two separate parts, including the sprung mass and the unsprung mass. The sprung mass of the vehicle includes all the components and systems located above the suspension system, such as the passenger compartments, cargoes, and seats. In contrast, the unsprung mass is only parts and components located below the suspension system, such as wheels, axles, hubs, brakes, and steering gearbox. If the mass of these two parts is optimally calculated and divided, the oscillation of the vehicle can be improved.

The conventional passive suspension system, which is used on most vehicles, only consists of springs and dampers. These springs and dampers have the hardness constantly ($K = \text{const}$; $C = \text{const}$). Therefore, the vehicle's oscillation when entering the bump on the road has not been much improved. In order to improve the efficiency of the suspension system, a variety of methods have been used and they are highly effective, such as air suspension, semiactive suspension, and active suspension. The air suspension system is equipped with many high-end vehicles or large passenger vehicles, and it can control the stiffness of the spring (air springs are used to replace conventional metal springs) [1, 2]. The semiactive suspension system can control the damping process by the current, and it is also very effective [3]. In [4], the efficiency of this system was introduced by Ren et al. The opinion of using the semiactive suspension system to improve the comfort of the vehicle is also shown in Chen et al.'s study [5]. Besides, the active suspension system which is equipped with the hydraulic actuator can generate the corresponding forces to improve the stability and comfort of the suspension system [6]. In [7], Marcu et al. introduced the active suspension system model. In addition, the active suspension system which uses an electromagnetic actuator also shows high performance when using it to replace the conventional passive suspension system [8]. Overall, when the conventional passive suspension system is replaced by modern suspension systems which are controlled by a controller, the vehicle's stability and comfort can be improved when the vehicle moves on the road. In particular, if the active suspension system is used, the safety and comfort parameters will also be significantly increased.

The active suspension system is equipped with luxury vehicles that come at a very high price. This suspension uses the hydraulic actuator to generate forces F_A to assist in minimizing the vehicle's oscillation. The actuator is controlled by the current which is generated from the controller based on the signals obtained from the sensors [9].

The active suspension system's control process is very important. There are many methods to control this system. In [10], Avesh and Srivastava used a PID controller to control the active suspension system. This is the linear control method for an object (SISO). This method is also used by Maurya and Bhangal in their paper [11]. Nagarkar

et al. used the LQR controller for the active suspension system model which is equipped with the quarter model [12]. Soliman used this controller for the space model of the vehicle which was established in [13]. According to [14], the LQG controller was designed based on a combination of the LQR controller and the Gaussian filter. This is a linear control method for the multiobject system (MIMO). In [15], the controller that used the state feedback method has also been proposed by Bello et al. Anh has compared and evaluated the effectiveness of the two control methods mentioned above in his research, and the advantages and disadvantages of the above methods have been shown [16].

To improve the efficiency of the active suspension system, many methods of nonlinear control have been studied. The paper by Wei and Su has provided the theoretical basis for the design of the sliding mode controller [17]. In [18], Bai and Guo also summarized the sliding mode controller design process which is used to control the hydraulic actuator of the active suspension system. In order to improve the efficiency of this method, Deshpande et al. proposed the design of the sliding mode controller using the disturbance observer [19]. The sliding mode controller helps the output signal track with the setpoint signal, and this controller is very stable and robust. However, the design and control process are quite complex. The H_∞ control method is also introduced in [20], and it is highly effective for the active suspension system. There are many robust controllers for the active suspension system that are also established [21–27]. These controllers are very stable against the change of the input signal. This has been demonstrated in [28]. Studies of adaptive control for the active suspension system have also been introduced [29–34]. The suspension system can adapt well to changes from the outside. In [35], Soleymani et al. used a fuzzy controller for the active suspension system. This control method also helps to make the vehicle more stable and comfortable [36–39]. The method of using the control network and the neural network has also been proposed in many papers [40, 41]. Besides, many control algorithms for the active suspension system have also been widely used [42–45]. Overall, the effectiveness of these methods is very high.

The control methods introduced above are single control methods. In some special cases, the oscillation of the vehicle is still very large. Therefore, these control methods need to be improved more optimally. Recently, researchers have proposed a method of integrating multiple controllers to improve the efficiency of the active suspension system [46, 47]. In [48], Lin et al. combined a fuzzy controller and a sliding mode controller. This combination is highly effective. According to [49], Lin et al. have also come up with their integrated controller for the active suspension system. Various ideas for the integrated controller have also been worked out [50–53]. Based on the stated ideas, this paper focuses on the introduction, design, and evaluation of the double-integrated controller for the active suspension system. The method of using the double-integrated controller is completely novelty and originality, and it can provide many positive effects. Until now, this method has rarely been used to control the operation of the active suspension systems

equipped with the vehicle. The contents of this paper are completely novel which can further contribute to the knowledge of vehicle's control. First, the vehicle dynamic model equipped with the active suspension system will be established. In this model, two actuators are used. Then, the controller of the hydraulic actuator will also be designed based on the set requirements. These two controllers operate independently of each other. Finally, the simulation will be conducted. Simulation results will be compared to evaluate the efficiency of the controllers.

2. Materials and Methods

2.1. Dynamic Model of the Vehicle. There are many types of dynamics models used to simulate the vehicle's oscillation when moving on the road. In the field of oscillation control, researchers often use simple dynamics models that can be easily combined with complex controllers. In this paper, the quarter dynamic model is used to simulate the oscillation of the vehicle. The suspension system on modern passenger vehicles is independent. At each wheel position, the active suspension system's controllers are equipped. These controllers operate independently of each other. Therefore, the results from the control process for the quarter dynamic model can also be applied to the spatial dynamic model which fully describes the vehicle's vibrations. The double-integrated controller is used in this model.

The diagrams of the quarter dynamic model and the hydraulic actuator model are shown in Figures 1 and 2, respectively.

The equations describing the vehicle's oscillation are written in the following form:

$$F_{ij}^{m_j} = (j-1)F_{KT} + (-1)^{j-1}(F_K + F_C + F_{A1} + F_{A2}), \quad j = \overline{1, 2}, \quad (1)$$

where

$$\begin{aligned} F_{ij} &= m_j \ddot{\xi}_j, \quad j \\ F_K &= K(\xi_2 - \xi_1), \\ F_C &= C(\dot{\xi}_2 - \dot{\xi}_1), \\ F_{KT} &= K_T(h - \xi_2). \end{aligned} \quad (2)$$

The value of the force which is generated from the actuator F_A is calculated as follows:

$$F_A = S_p \Delta P. \quad (3)$$

With the input voltage provided by the PID controller, the displacement of the servo valve which is inside the hydraulic cylinder can be calculated by a linear filter:

$$x_{sv} = \frac{1}{\tau} \int (k_{sv} u(t) - x_{sv}) dt. \quad (4)$$

The flow of liquid through the valve:

$$Q = \frac{\sigma_3}{\sigma_1} x_{sv} \sqrt{P_s - \text{sgn}(x_{sv}) \Delta P}. \quad (5)$$

The change in pressure ΔP is shown by

$$\Delta P = \sigma_1 \int \left(Q - \frac{\sigma_2}{\sigma_1} \Delta P - S_p \dot{x}_s \right) dt. \quad (6)$$

The equation showing the relationship between the pressure change of the liquid and the displacement of the servo valve is rewritten as follows:

$$\begin{aligned} \Delta P &= \sigma_3 \int \left(x_{sv} \sqrt{P_s - \text{sgn}(x_{sv}) \Delta P} \right) dt \\ &\quad - \sigma_2 \int \Delta P dt - \sigma_1 S_p \int \dot{x}_s dt. \end{aligned} \quad (7)$$

From (3) and (7), the force generated from the hydraulic actuator F_A will be a function that changes over time:

$$\begin{aligned} F_A &= S_p \Delta P = S_p \left(\sigma_3 \int \left(x_{sv} \sqrt{P_s - \text{sgn}(x_{sv}) \Delta P} \right) dt \right. \\ &\quad \left. - \sigma_2 \int \Delta P dt - \sigma_1 S_p \int \dot{x}_s dt \right). \end{aligned} \quad (8)$$

$$\text{Let } S_p \sigma_3 = \mu_3 S_p \sigma_2 = \mu_2 S_p^2 \sigma_1 = \mu_1:$$

$$\Rightarrow F_A = S_p \Delta P = \mu_3 f_3(t) - \mu_2 f_2(t) - \mu_1 f_1(t), \quad (9)$$

where $f_i(t)$ are functions that depend on displacement of the servo valve, displacement of the piston, and changing pressure of the hydraulic actuator.

Once the vehicle's dynamics model and actuator's dynamics model have been established, the controller needs to be designed based on the determined factors to ensure and improve the quality of the active suspension system.

2.2. Double-Integrated Controller. There is a variety of control methods for the active suspension system. Almost, these controllers only work independently. To optimize the oscillation of the suspension system, an integrated control method is proposed. The first controller is used to control the acceleration of the sprung mass. The other controller is used to control the displacement of the sprung mass. These two values are optimally controlled to enhance the efficiency of the active suspension system. In order to satisfy these mentioned requirements, the method of integrating two PID controllers is selected.

The PID controller is a linear controller commonly used in the industrial and automation fields. This controller consists of three stages: the proportional stage (P), the integral stage (I), and the derivative stage (D). The PID controller is used to control the SISO object according to the state feedback principle. This controller helps to bring the value of the error $e(t)$ of the system approach zero to satisfy basic requirements of the quality process, including

If the value of $e(t)$ is large, the tuning signal $u(t)$ will also be larger based on the component $u_p(t)$

If the value of $e(t)$ has not approached zero, the controller will continue to generate the tuning signal by component $u_i(t)$

If the change of the value of $e(t)$ is larger, the appropriate response of $u(t)$ will be faster by component $u_d(t)$

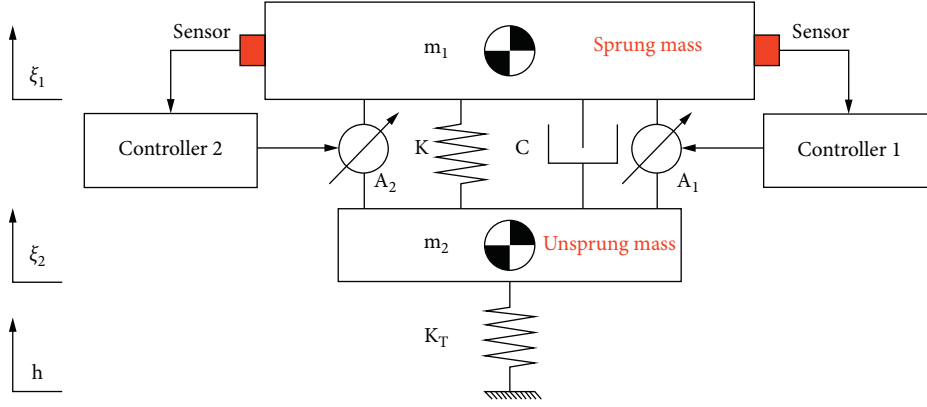

FIGURE 1: Quarter vehicle dynamic model.

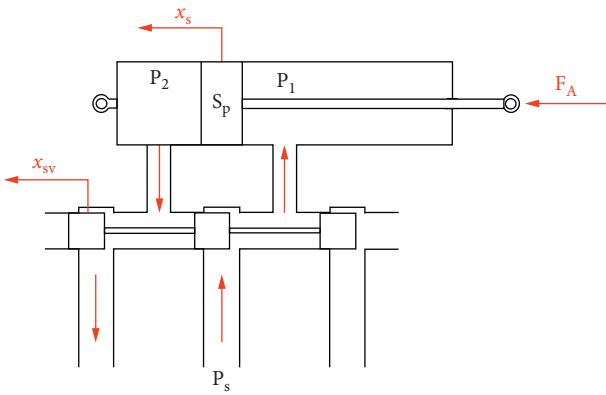

FIGURE 2: Hydraulic actuator of the active suspension system.

The mathematical model of the PID controller is written in the following form:

$$u(t) = k_p \left[e(t) + \frac{1}{T_I} \int_0^t e(\tau) d\tau + T_D \dot{e}(t) \right], \quad (10)$$

where $e(t)$ is the input signal of the controller, $u(t)$ is the output signal of the controller, k_p is the proportional coefficient, T_I is the integral coefficient, and T_D is the derivative coefficient.

Based on the mathematical model of PID controller (10), the transfer function of the controller has the following form:

$$R(s) = k_p \left(1 + \frac{1}{T_I s} + T_D s \right). \quad (11)$$

The diagram of the double-integrated controller is shown in Figure 3.

The parameters of the PID controller need to be predefined. The selection of these parameters is extremely important. It may affect the performance of the controller. These parameters can be selected based on the experience of the designer. Besides, several other methods can also be used to determine the parameters of the controller such as genetic algorithm (GA) and ant colony optimization (ACO). In this paper, the Ziegler–Nichols method is used to define the

parameters of the PID controller. This method is quite simple, and it helps the designer to easily determine the necessary parameters. According to this method, the proportional coefficient k_p , integral coefficient T_I , and derivative coefficient T_D are determined when the system oscillates stably:

$$\begin{aligned} k_p &= \lambda_1 k_{th}, \\ T_I &= \lambda_2 T_{th}, \\ T_D &= \lambda_3 T_{th}, \end{aligned} \quad (12)$$

where λ_i is the coefficient of the controller.

After the controller has been designed, the results of the calculation and simulation process are shown in Section 3.

3. Results and Discussion

3.1. Simulation Conditions. Before proceeding to simulate and evaluate the vehicle's oscillation, the conditions of the simulation need to be defined in advance. These include specification conditions and road conditions.

The specification conditions of the vehicle and the hydraulic actuator are shown in Table 1. The specific parameters of the hydraulic actuator are specific to its construction, such as the piston area, the initial pressure of the liquid, and the delay time. Some other constant σ_i is calculated based on the leakage of the liquid inside the actuator. The simulation process is performed based on the parameters of this actuator [54].

There are many types of road surface conditions that are used in oscillation studies of the vehicle. In particular, the sine function is often used. In this research, there are two types of the bump in the road that are used corresponding to 2 cases, as shown in Figure 4. The function to represent the road surface is given the following form:

$$h = A \sin(\omega t + \phi), \quad (13)$$

where A is the amplitude of the oscillation, ω is the angular frequency, and ϕ is the initial phase.

The parameters of the excitation from the road surface are given in Table 2. The excitation of the oscillation in case 1 has an amplitude and frequency smaller than those in case 2.

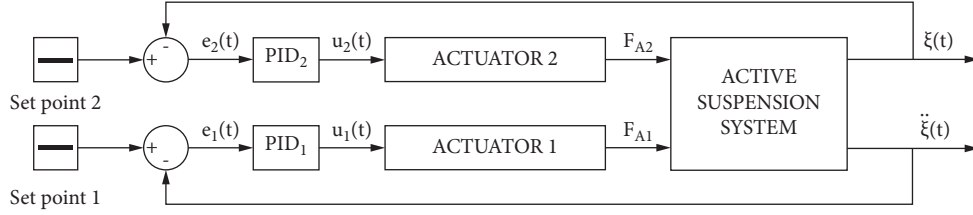

FIGURE 3: The diagram of the double-integrated controller.

TABLE 1: Specific parameters of the vehicle.

Description	Symbol	Value	Unit
Sprung mass	m_1	400	kg
Unsprung mass	m_2	45	kg
Spring coefficient	K	25×10^3	N/m
Tire coefficient	K_T	150×10^3	N/m
Damper coefficient	C	2.2×10^3	Ns/m
Actuator coefficient	σ_1	4.5×10^{13}	N/m^5
Actuator coefficient	σ_2	1	s^{-1}
Actuator coefficient	σ_3	1.5×10^9	$N/kg^{1/2}m^{5/2}$
Time constant	τ	2.5×10^{-3}	s
Piston cross-sectional area	S_p	3.5×10^{-4}	m^2
Supply pressure	P_s	1056240	N/m^2
Servo valve gain	k_{sv}	1×10^{-3}	m/V

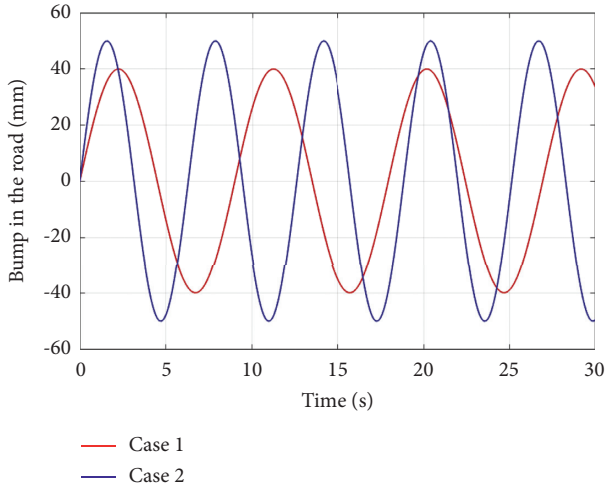

FIGURE 4: Bump in the road.

TABLE 2: Parameter of the condition from the road surface.

	Case 1	Case 2	Unit
A	40	50	mm
ω	0.7	1	rad/s
φ	0	0	rad

3.2. Results. The results of the simulation are given corresponding to the two cases above. In each case, the values of the displacement of the sprung mass, the acceleration of the sprung mass, and the displacement of the suspension system are compared with the following situations: vehicle equipped with the passive suspension, the active suspension system with a single controller (SC), and the active suspension

system with the double-integrated controllers (DC). The single controller (SC) only controls the value of the acceleration of the sprung mass. The double-integrated controller (DC) controls both the values of acceleration and displacement of the sprung mass.

3.2.1. Case 1. The graph of Figure 5 shows the change of the displacement of the sprung mass over time. If the vehicle uses the conventional passive suspension system, this value is quite large, reaching 40.0 (mm), equivalently the amplitude of the oscillation of the road surface. If the vehicle uses the active suspension system with a single controller, this value drops drastically from 40.0 (mm) to 17.5 (mm). Besides, if the active suspension system with the double-integrated controller is equipped with the vehicle, the value of the displacement of the sprung mass only fluctuates around a very small threshold, from 2.2 (mm) to 2.5 (mm). This is an ideal value for a vehicle's oscillation when moving on the road.

The acceleration of the vehicle body (sprung mass) is one of the most important indicators to evaluate the smoothness and comfort of the vehicle while traveling on the road. If the amplitude of oscillation of acceleration is too great, passengers will feel uncomfortable. Figure 6 shows the change in acceleration of the sprung mass corresponding to these simulation situations. If the vehicle uses only the conventional passive suspension system, the maximum value of the acceleration of the sprung mass is very large, reaching $0.185 (m/s^2)$. However, this value decreases gradually and fluctuates steadily in the range from -0.022 to $0.022 (m/s^2)$. Also, this value will fluctuate more steadily when the vehicle is equipped with the active suspension system. If the single controller is used for the active suspension system, the steady fluctuation's amplitude of the acceleration of the sprung mass is only $0.009 (m/s^2)$. Besides, if the vehicle is equipped with the double-integrated controllers for the active suspension system, this value will fluctuate steadily over a very small range, only from 0.001 to $0.002 (m/s^2)$. Therefore, the vehicle's smoothness and comfort will be greatly improved. Because the double-integrated controller which uses 2 PID controllers can create an interaction with each other, the value of the acceleration of the sprung mass will fluctuate continuously, and this is called the "chattering" phenomenon. However, this phenomenon has almost no effect on the vehicle's oscillation because its value is tiny.

To ensure that the displacement and acceleration of the vehicle body (sprung mass) are small, the displacement of the suspension system needs to be continuously changed in response to the bump in the road. Figure 7 shows the change

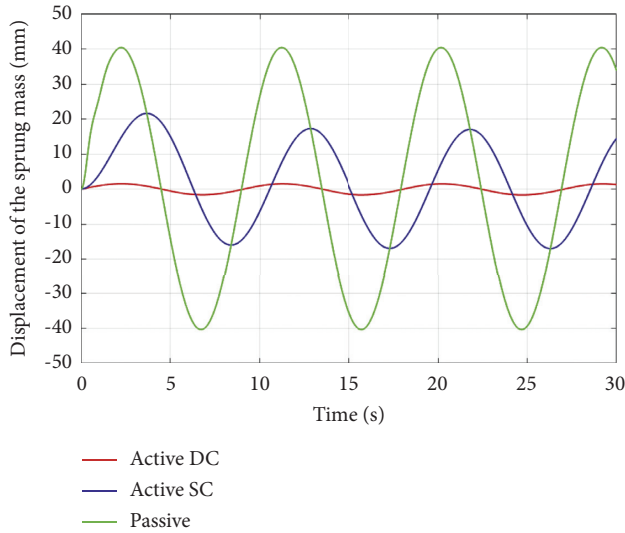

FIGURE 5: Displacement of the sprung mass.

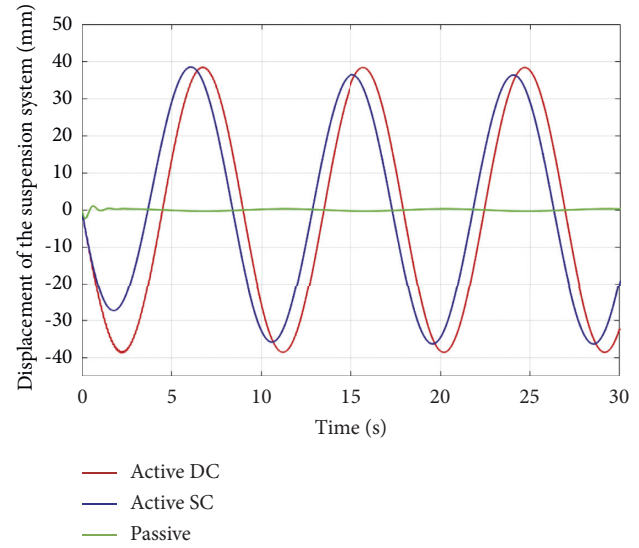

FIGURE 7: Displacement of the suspension system.

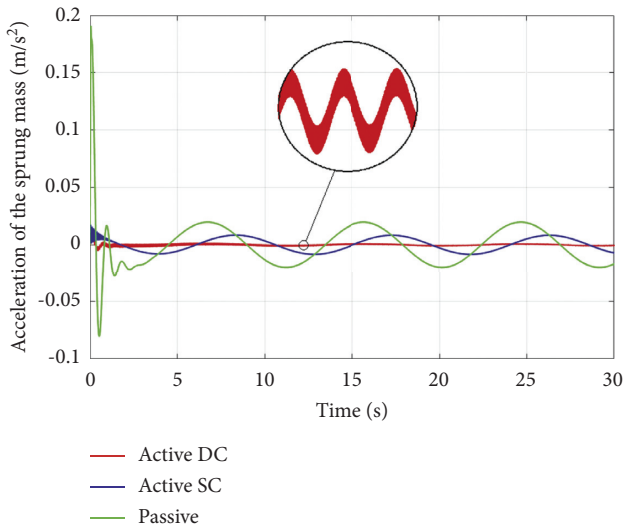

FIGURE 6: Acceleration of the sprung mass.

in the displacement of the suspension system over time. When the vehicle is equipped with the active suspension system, the travel of the suspension system will track the bump in the road which causes the oscillation for the vehicle. Contrary, if the vehicle uses only the passive suspension system, the suspension system will not almost displace. Therefore, this suspension system can be considered a very hard block, and it directly affects the comfort and stability of the vehicle.

The results of the simulation in case 1 are summarized in Tables 3 and 4. It is clear that the displacement and acceleration of the sprung mass are greatly reduced when the vehicle is equipped with the active suspension system using the double-integrated controller. Its maximum value only reaches 6.25% and 9.10% compared to the case of the vehicle using the conventional passive suspension system. Besides, its average value which is calculated by RMS is also only about 3.91% and 4.67% compared to the above case.

3.2.2. *Case 2.* In this case, the simulation and calculation are also performed similarly to case 1. Because the value of the bump in the road is larger, the amplitude of the oscillation of the vehicle body will also change more.

The graph of Figure 8 shows the displacement of the sprung mass corresponding to the following situations: vehicle using the passive suspension, the active suspension with a single controller, and the active suspension with double-integrated controllers. Obviously, the displacement of the sprung mass when the vehicle is equipped with the active suspension with the double-integrated controller is very small, ranging from 2.0 to 3.0 (mm). Meanwhile, this value for the use of the passive suspension is very large, about 50.0 (mm). The active suspension system which uses the single controller can reduce this value to 15.6 (mm).

The value of the acceleration of the sprung mass in case 2 is also greater than that of case 1 (Figure 9). Overall, the active suspension's double-integrated controller can significantly improve this value, and the amplitude of oscillation is only from 0.002 to 0.003 (m/s^2). However, the "chattering" phenomenon can still happen. Because this value is so small, the "chattering" phenomenon does not affect the comfort and stability of the user. The value of the suspension's displacement in this case is similar to that in case 1. When the vehicle uses the active suspension system, this value tends to change continuously and is in keeping with the bump in the road (Figure 10). If the vehicle is equipped with the active suspension system is controlled by double-integrated controllers, the vehicle's stability and comfort will be greatly improved.

The results of this simulation are shown in Tables 5 and 6. In general, the change in displacement and acceleration of the sprung mass is quite large when the vehicle is equipped with the active suspension system controlled by the double-integrated controller compared to other cases. Therefore, the double-integrated control method for the active suspension system can improve the stability and comfort of the vehicle.

TABLE 3: The maximum value of case 1.

Description	Passive		Active SC		Active DC	
	Value	Percent	Value	Percent	Value	Percent
Displacement of the sprung mass	40.0	100	17.5	43.75	2.5	6.25
Acceleration of the sprung mass	0.022	100	0.009	40.90	0.002	9.10

TABLE 4: The average value of case 1.

Description	Passive		Active SC		Active DC	
	Value	Percent	Value	Percent	Value	Percent
Displacement of the sprung mass	28.851	100	12.310	42.67	1.127	3.91
Acceleration of the sprung mass	0.0214	100	0.0058	27.10	0.0010	4.67

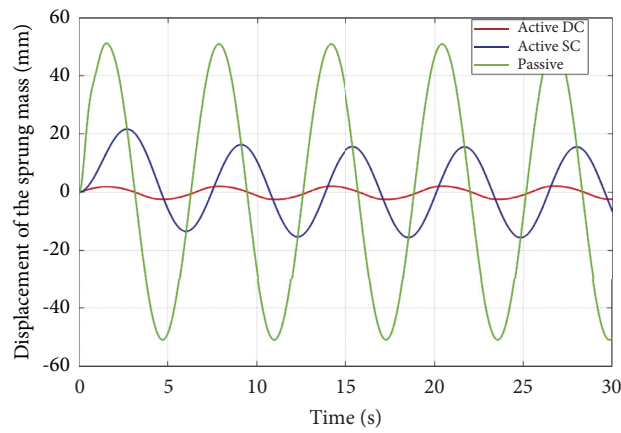

FIGURE 8: Displacement of the sprung mass.

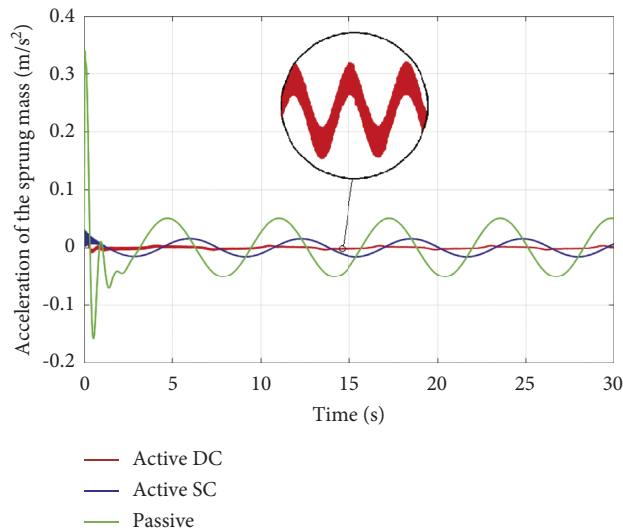

FIGURE 9: Acceleration of the sprung mass (m/s^2).

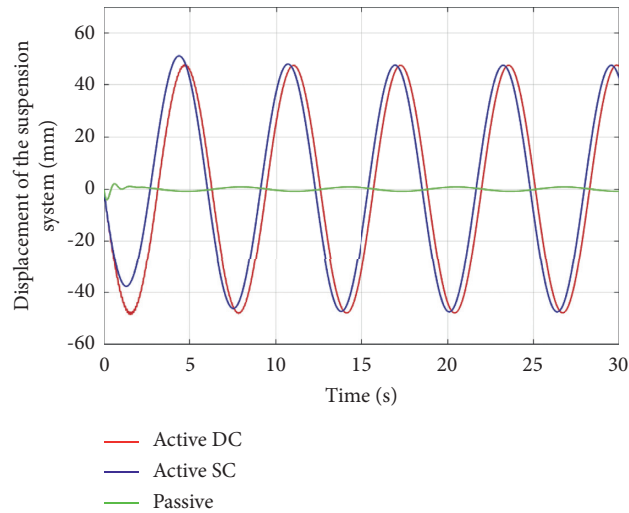

FIGURE 10: Displacement of the suspension system.

TABLE 5: The maximum value of case 2.

Description	Passive		Active SC		Active DC	
	Value	Percent	Value	Percent	Value	Percent
Displacement of the sprung mass	50.0	100	15.6	31.20	3.0	6.00
Acceleration of the sprung mass	0.049	100	0.023	46.94	0.003	6.12

TABLE 6: The average value of case 2.

Description	Passive		Active SC		Active DC	
	Value	Percent	Value	Percent	Value	Percent
Displacement of the sprung mass	36.042	100	11.455	31.78	1.613	4.48
Acceleration of the sprung mass	0.0462	100	0.0110	23.81	0.0022	4.77

4. Conclusions

The oscillation of the vehicle when moving on the road is an extremely important problem. This can directly affect the comfort, stability, and safety of the vehicle and its passengers. The vehicle's suspension system is used to control and extinguish oscillation from the road surface to the vehicle body. To evaluate the effectiveness of the suspension system and the comfort of the vehicle, several vehicle parameters are considered, such as displacement of the vehicle body (sprung mass), acceleration of the vehicle body (sprung mass), and displacement of the suspension system.

The conventional passive suspension system includes only mechanical springs and dampers. This suspension system is unable to fully meet the requirements for the stability and comfort of the vehicle. In order to improve the comfort and safety of passengers, many modern suspension systems have been used, such as the air suspension system, the semiactive suspension system, and the active suspension system. In particular, the active suspension system offers many outstanding efficiencies.

The active suspension system is used in high-end vehicles and is controlled automatically by the controller. There are many methods used to control the active suspension system

that has been suggested by researchers in their papers. These methods have very good results. However, they cannot completely meet the oscillation problems of the vehicle in special cases. Therefore, these control methods need to be improved and combined optimally. In this research, the author has proposed to use the double-integrated controller for optimum performance of the active suspension system. The double-integrated control method uses two hydraulic actuators, which generate force to act on the sprung mass and unsprung mass. These two actuators are controlled by two different controllers. This is a completely novel and original method, and it has never been used before.

This paper focuses on establishing the dynamic model of the vehicle and the dynamic model of the hydraulic actuator. Besides, the double-integrated controller which consisted of 2 PID controllers was designed. The results of the research show that when the vehicle is equipped with the active suspension system which is controlled by the double-integrated controller, the values of the displacement and the acceleration of the sprung mass are both significantly reduced. Also, the oscillation amplitude of these values is very small. Compared with previous research studies that only used traditional control methods, the use of the double-integrated controller, which is described in

this paper, has brought outstanding efficiency. Hence, the vehicle's comfort and stability can be improved. The "chattering" phenomenon appeared when using the double-integrated controller. Usually, this phenomenon occurs only with nonlinear controllers such as the tracking-sliding mode controller. Because the double-integrated controller consists of two PID controllers working at the same time, they can interfere with each other and create this phenomenon. However, this phenomenon does not affect the comfort of the vehicle.

Finding and using the double-integrated controller for the active suspension system has great practical significance. It helps the vehicle to improve the smoothness and comfort. Besides, the safety and stability of the vehicle are also enhanced. Further, this is the basis for developing more complex studies later.

5. Future Recommendation

Although the double-integrated controller for the active suspension system has shown its outstanding advantages over other conventional controllers, however, this research only used the linear control method for this system. Besides, the "chattering" phenomenon still occurs. It may cause minor interactions during system operation. In the coming time, the control methods using the double-integrated controllers will continue to be researched and improved to reduce the "chattering" phenomenon and further improve efficiency by using the nonlinear control methods as sliding mode control, robust control, adaptive control, etc. In addition, combined intelligent control methods can also be used such as fuzzy logic, network neural, PID fuzzy, and PI GA. In the future, the double-integrated controllers that are equipped with the vehicle may become more popular.

Nomenclature

F_C :	Force of the damper, N
F_K :	Force of the spring, N
F_{KT} :	Force of the tire, N
F_i :	Force of inertia, N
F_{A1} :	Force of the actuator 1, N
F_{A2} :	Force of the actuator 2, N
ξ_1 :	Displacement of the sprung mass, m
ξ_2 :	Displacement of the unsprung mass, m
h :	Bump in the road, m.

Data Availability

No data were used to support the findings of this study.

Conflicts of Interest

The author declares that there are no conflicts of interest.

References

- [1] H. J. Abid, J. Chen, and A. A. Nassar, "Equivalent air spring suspension model for quarter-passive model of passenger vehicles," *International Scholarly Research Notices*, vol. 2015, Article ID 974020, 6 pages, 2015.
- [2] F. de Melo, A. Pereira, and A. Morais, "The simulation of an automotive air spring suspension using a pseudo-dynamic procedure," *Applied Sciences*, vol. 8, no. 7, Article ID 1049, 2018.
- [3] A. Aljarbouh and M. Fayaz, "Hybrid modelling and sliding mode control of semi-active suspension systems for both ride comfort and road-holding," *Symmetry*, vol. 12, no. 8, Article ID 1286, 2020.
- [4] H. Ren, Y. Zhao, S. Chen, and G. Lu, "State observe based adaptive sliding mode control for semi-active suspension systems," *Journal of Vibroengineering*, vol. 17, no. 3, pp. 1464–1475, 2015.
- [5] B. C. Chen, Y. H. Shiu, and F. C. Hsieh, "Sliding-mode control for semi-active suspension with actuator dynamics," *Vehicle System Dynamics*, vol. 49, no. 1-2, pp. 277–290, 2011.
- [6] X. D. Xue, K. W. E. Cheng, Z. Zhang et al., "Study of art automotive active suspensions," in *Proceedings of the 4th International Conference on Power Electronics Systems and Applications*, pp. 1–7, Hong Kong, China, June 2011.
- [7] S. Marcu, D. Popa, N. D. Stanescu, and N. Pandrea, "Model for the study of active suspensions," *IOP Conference Series: Materials Science and Engineering*, vol. 252, Article ID 012032, 2017.
- [8] F. Beltran-Carbajal, A. Valderrabano-Gonzalez, A. Favela-Contreras, J. L. Hernandez-Avila, I. Lopez-Garcia, and R. Tapia-Olvera, "An active vehicle suspension control approach with electromagnetic and hydraulic actuators," *Actuators*, vol. 8, no. 2, p. 35, 2019.
- [9] A. F. M. Riduan, N. Tamaldin, A. Sudrajat, and F. Ahmad, "Review on active suspension system," *SHS Web of Conferences*, vol. 49, Article ID 02008, 2018.
- [10] M. Avesh and R. Srivastava, "Modeling simulation and control of active suspension system in matlab simulink environment," in *Proceedings of the Students Conference on Engineering and Systems*, pp. 1–6, Uttar Pradesh, India, March 2012.
- [11] V. K. Maurya and N. S. Bhangal, "Optimal control of vehicle active suspension system," *Journal of Automation and Control Engineering*, vol. 6, no. 1, pp. 22–26, 2018.
- [12] M. P. Nagarkar, G. J. Vikhe, K. R. Borole, and V. M. Nandedkar, "Active control of quarter car suspension system using linear quadratic regulator," *International Journal of Automotive and Mechanical Engineering*, vol. 3, no. 1, pp. 364–372, 2011.
- [13] A. M. A. Soliman, "Adaptive LQR control strategy for active suspension system," *SAE Technical Paper*, p. 9, 2011.
- [14] H. Pang, Y. Chen, and J. N. Chen, "Design of LQG controller for active suspension without considering road input signals," *Shock and Vibration*, vol. 2017, Article ID 6573567, 13 pages, 2017.
- [15] M. M. Bello, A. Akramin Shafie, and R. Khan, "Active vehicle suspension control using full state-feedback controller," *Advanced Materials Research*, vol. 1115, pp. 440–445, 2015.
- [16] N. T. A. Nguyen Tuan Anh, "Control an active suspension system by using PID and LQR controller," *International Journal of Mechanical and Production Engineering Research and Development*, vol. 10, no. 3, pp. 7003–7012, 2020.
- [17] S. Wei and X. Su, "Sliding mode control design for active suspension systems using quantum particle swarm optimization," *International Journal of Vehicle Design*, vol. 81, no. 1-2, pp. 93–114, 2019.
- [18] R. Bai and D. Guo, "Sliding-mode control of the active suspension system with the dynamics of a hydraulic actuator," *Complexity*, vol. 2018, Article ID 5907208, 6 pages, 2018.

- [19] V. S. Deshpande, M. Bhaskara, and S. B. Phadke, "Sliding mode control of active suspension systems using a disturbance observer," in *Proceedings of the 12th International Workshop on Variable Structure Systems*, pp. 70–75, Maharashtra, India, January 2012.
- [20] S. M. H. Rizvi, M. Abid, A. Q. Khan, S. G. Satti, and J. Latif, "H ∞ control of 8 degrees of freedom vehicle active suspension system," *Journal of King Saud University - Engineering Sciences*, vol. 30, no. 2, pp. 161–169, 2018.
- [21] M. Kaleemullah, W. Faris, and N. M. Ghazaly, "Analysis of active suspension control policies for vehicle using robust controllers," *International Journal of Advanced Science and Technology*, vol. 28, no. 16, pp. 836–855, 2019.
- [22] N. Singh, H. Chhabra, and K. Bhangal, "Robust control of vehicle active suspension system," *International Journal of Control and Automation*, vol. 9, no. 6, pp. 149–160, 2016.
- [23] H. Wu, L. Zheng, Y. Li, Z. Zhang, and Y. Yu, "Robust control for active suspension of hub-driven electric vehicles subject to in-wheel motor magnetic force oscillation," *Applied Sciences*, vol. 10, no. 11, p. 3929, 2020.
- [24] Y. Huang, J. Na, X. Wu, G.-B. Guo, and Y. Gao, "Robust adaptive control for vehicle active suspension systems with uncertain dynamics," *Transactions of the Institute of Measurement and Control*, vol. 40, no. 4, pp. 1237–1249, 2018.
- [25] M. Gudarzi and A. Oveisi, "Robust control for ride comfort improvement of an active suspension system considering uncertain driver's biodynamics," *Journal of Low Frequency Noise, Vibration and Active Control*, vol. 33, no. 3, pp. 317–339, 2014.
- [26] J. Yao, M. Wang, and Y. Bai, "Automobile active tilt based on active suspension with H ∞ robust control," *Proceedings of the Institution of Mechanical Engineers - Part D: Journal of Automobile Engineering*, vol. 235, no. 5, pp. 1320–1329, 2021.
- [27] M. Gong and X. Yan, "Robust control strategy of heavy vehicle active suspension based on road level estimation," *International Journal of Automotive Technology*, vol. 22, no. 1, pp. 141–153, 2021.
- [28] T. P. J. van der Sande, B. L. J. Gysen, I. J. M. Besselink, J. J. H. Paulides, E. A. Lomonova, and H. Nijmeijer, "Robust control of an electromagnetic active suspension system: simulations and measurements," *Mechatronics*, vol. 23, no. 2, pp. 204–212, 2013.
- [29] W. Sun, Z. Zhao, and H. Gao, "Saturated adaptive robust control for active suspension systems," *IEEE Transactions on Industrial Electronics*, vol. 60, no. 9, pp. 3889–3896, 2013.
- [30] A. Alleyne and J. K. Hedrick, "Nonlinear adaptive control of active suspensions," *IEEE Transactions on Control Systems Technology*, vol. 3, no. 1, pp. 94–101, 1995.
- [31] S. Cetin, "Adaptive vibration control of a nonlinear quarter car model with an electromagnetic active suspension," *Journal of Vibroengineering*, vol. 17, no. 6, pp. 3063–3078, 2015.
- [32] Y. Huang, J. Na, X. Wu, X. Liu, and Y. Guo, "Adaptive control of nonlinear uncertain active suspension systems with prescribed performance," *ISA Transactions*, vol. 54, pp. 145–155, 2015.
- [33] Z. J. Fu, B. Li, X. B. Ning, and W.-D. Xie, "Online adaptive optimal control of vehicle active suspension systems using single-network approximate dynamic programming," *Mathematical Problems in Engineering*, vol. 2017, Article ID 4575926, 9 pages, 2017.
- [34] S. Tong, S. Sui, and Y. Li, "Fuzzy adaptive output feedback control of MIMO nonlinear systems with partial tracking errors constrained," *IEEE Transactions on Fuzzy Systems*, vol. 23, no. 4, pp. 729–742, 2015.
- [35] M. Soleymani, M. Montazeri-Gh, and R. Amiryan, "Adaptive fuzzy controller for vehicle active suspension system based on traffic conditions," *Scientia Iranica*, vol. 19, no. 3, pp. 443–453, 2012.
- [36] J. Na, Y. Huang, X. Wu, S.-F. Su, and G. Li, "Adaptive finite-time fuzzy control of nonlinear active suspension systems with input delay," *IEEE Transactions on Cybernetics*, vol. 50, no. 6, pp. 2639–2650, 2020.
- [37] S. Palanisamy and S. Karuppan, "Fuzzy control of active suspension system," *Journal of Vibroengineering*, vol. 18, no. 5, pp. 3197–3204, 2016.
- [38] P. Senthilkumar, K. Sivakumar, R. Kanagarajan, and S. Kuberan, "Fuzzy control of active suspension system using full car model," *Mechanika*, vol. 24, no. 2, pp. 240–247, 2018.
- [39] Y. Q. Sun, L. F. Zhao, and W. Xiang, "A fuzzy logic controller for vehicle-active suspension systems," *Advanced Materials Research*, vol. 805–806, pp. 1645–1649, 2013.
- [40] S. F. Youness and E. C. Lobusov, "Networked control for active suspension system," *Procedia Computer Science*, vol. 150, pp. 123–130, 2019.
- [41] Y.-J. Liu, Q. Zeng, S. Tong, C. L. P. Chen, and L. Liu, "Adaptive neural network control for active suspension systems with time-varying vertical displacement and speed constraints," *IEEE Transactions on Industrial Electronics*, vol. 66, no. 12, pp. 9458–9466, 2019.
- [42] M. Soh, H. Jang, J. Park, Y. Sohn, and K. Park, "Development of preview active suspension control system and performance limit analysis by trajectory optimization," *International Journal of Automotive Technology*, vol. 19, no. 6, pp. 1001–1012, 2018.
- [43] M. M. Elmadany, "Control and evaluation of slow-active suspensions with preview for a full car," *Mathematical Problems in Engineering*, vol. 2012, Article ID 375080, 19 pages, 2012.
- [44] A. Y. Babawuro, N. M. Tahir, M. Muhammed, and A. U. Sambo, "Optimized state feedback control of quarter car active suspension system based on LMI algorithm," *Journal of Physics: Conference Series*, vol. 1502, Article ID 012019, 2019.
- [45] M. M. Atef, M. S. Soliman, and A. B. Sharkawy, "Vehicle active suspension system performance using different control strategies," *International Journal of Engineering Trends and Technology*, vol. 30, no. 2, pp. 106–114, 2015.
- [46] Y. M. Sam, K. Hudha, and J. H. S. Osman, "Proportional-integral sliding mode control of a hydraulically actuated active suspension system: force tracking and disturbance rejection control on non-linear quarter car model," *International Journal of Vehicle Systems Modelling and Testing*, vol. 2, no. 4, pp. 391–410, 2007.
- [47] H. Xiao, W. Chen, H. Zhou, and J. W. Zu, "Integrated vehicle dynamics control through coordinating electronic stability program and active suspension system," in *Proceedings of the IEEE International Conference on Mechatronics and Automation*, pp. 1150–1155, Chanchun, China, August 2009.
- [48] B. Lin, X. Su, and X. Li, "Fuzzy sliding mode control for active suspension system with proportional differential sliding mode observer," *Asian Journal of Control*, vol. 21, no. 1, pp. 1–13, 2019.
- [49] J. Lin, R.-J. Lian, C.-N. Huang, and W.-T. Sie, "Enhanced fuzzy sliding mode controller for active suspension systems," *Mechatronics*, vol. 19, no. 7, pp. 1178–1190, 2009.
- [50] W. Li, H. Du, D. Ning, and W. Li, "Robust adaptive sliding mode PI control for active vehicle seat suspension systems," in *Proceedings of the 31st Chinese Control and Decision Conference*, pp. 5403–5408, Nanchang, China, June 2019.

- [51] Z. Fang, W. Shu, D. Du, B. Xiang, Q. He, and K. He, "Semi-active suspension of a full-vehicle model based on double-loop control," *Procedia Engineering*, vol. 16, pp. 428–437, 2011.
- [52] F. Junyao, X. Wenping, and L. Guohai, "Vibration control for vehicle active suspension based on ANFIS method," in *Proceedings of the 36th Chinese Control Conference*, pp. 9602–9606, Dalian, China, July 2017.
- [53] P. Gandhi, S. Adarsh, and K. I. Ramachandran, "Performance analysis of half car suspension model with 4 DOF using PID, LQR, FUZZY and ANFIS controllers," *Procedia Computer Science*, vol. 115, pp. 2–13, 2017.
- [54] T. A. Nguyen, "Control the hydraulic stabilizer bar to improve the stability of the vehicle when steering," *Mathematical Modelling of Engineering Problems*, vol. 8, no. 2, pp. 199–206, 2021.